



**ENGLISH TRANSLATION**

**TRANSMISSION SYSTEM FOR DIGITAL  
TERRESTRIAL TELEVISION BROADCASTING**

**ARIB STANDARD**

**ARIB STD-B31 Version 1.6**

Established:	May, 2001	Version 1.0
Revised:	November 15, 2002	Version 1.1
Revised:	January 24, 2002	Version 1.2
Revised:	February 6, 2003	Version 1.3
Revised:	June 5, 2003	Version 1.4
Revised:	July 29, 2003	Version 1.5
Revised:	November 30, 2005	Version 1.6

**Association of Radio Industries and Businesses**

## General Notes to the English translation of ARIB Standards and Technical Reports

1. The copyright of this document is ascribed to the Association of Radio Industries and Businesses (ARIB).
2. All rights reserved. No part of this document may be reproduced, stored in a retrieval system, or transmitted, in any form or by any means, without the prior written permission of ARIB.
3. The ARIB Standards and ARIB Technical Reports are usually written in Japanese and approved by the ARIB Standard Assembly. This document is a translation into English of the approved document for the purpose of convenience of users. If there are any discrepancies in the content, expressions, etc., between the Japanese original and this translated document, the Japanese original shall prevail.
4. The establishment, revision and abolishment of ARIB Standards and Technical Reports are approved at the ARIB Standard Assembly, which meets several times a year. Approved ARIB Standards and Technical Reports, in their original language, are made publicly available in hard copy, CDs or through web posting, generally in about one month after the date of approval. The original document of this translation may have been further revised and therefore users are encouraged to check the latest version at an appropriate page under the following URL:  
<http://www.arib.or.jp/english/index.html>

## TOTAL CONTENTS

Foreword

Transmission System for Digital Terrestrial Television digital broadcasting ..... 1

Appendix

Operation Guidelines for Digital Terrestrial Television Broadcasting..... 67

References ..... 119

## Foreword

The Association of Radio Industries and Businesses establishes as ARIB standards the basic technical requirements such as standard various radio-equipment specifications with regard to various radio-wave utilization systems, with the participation of broadcasting-equipment manufacturers, broadcasting service carriers, radio-equipment manufacturers, common carriers, and their users.

ARIB standards are private standards established by compiling private and voluntary standards that have been developed to increase convenience for broadcasting-equipment manufacturers, broadcasting service carriers, radio-equipment manufacturers, common carriers, and their users, such as by ensuring the appropriate quality of and compatibility between broadcasting and radio facilities. These standards are intended to be used in conjunction with national technical standards established for the purpose of ensuring the efficient use of available frequencies and avoiding radio interference between users.

This ARIB standard was established with regard to a transmission system for digital terrestrial television broadcasting. In order to ensure fairness and transparency in the establishment process, the standard was determined as the consensus of all participants in our standard meeting, selected without bias from among a broad range of interested parties - foreign and domestic, firms and individuals - including broadcasting-equipment manufacturers, broadcasting service carriers, radio equipment manufacturers, common carriers, and their users.

We hope that the standard will be widely used by broadcasting-equipment manufacturers, broadcasting service carriers, radio-equipment manufacturers, common carriers, and their users.

### Notice:

This standard does not describe industrial property rights mandatory to this standard. However, the right proprietor of the industrial property rights has expressed that "Industrial property rights related to this standard, listed in the annexed table below, are possessed by the applicator shown in the list. However, execution of the right listed in the annexed table below is permitted indiscriminately, without exclusion, under appropriate condition, to the user of this standard. In the case when the user of this standard possesses the mandatory industrial property rights for all or part of the contents specified in this standard, and when he asserts his rights, it is not applied."

Annexed table

Patent Applicant/ Holder	Name of Patent	Registration No./ Application No.	Remarks
Japan Broadcasting Corporation (NHK)	誤り訂正復号回路	特許 1585258	Japan
	誤り訂正復号方式	特許 1587162	Japan, United States, Canada, Korea
	誤り検出回路	特許 1587174	Japan, United States
	誤り訂正復号方式	特許 1707686	Japan, United States, Canada, Korea
	直交周波数分割多重デジタル信号送信装置および受信装置	特許 2904986	Japan
	Method and apparatus for digital transmission using orthogonal frequency division multiplexing	5406551	United States
		0553841	United Kingdom
		0553841	Germany
		0553841	France
	符号化変調装置および復調装置	特許 2883238	Japan
	直交周波数分割多重変調信号伝送方式	特許 3110244	Japan
	放送方式および送受信機	特開平 8-294098	Japan
	デジタル信号の送信方法、受信方法、送信装置および受信装置	特開平 9-46307	Japan
	デジタル信号伝送方法および受信機	特開平 10-93521	Japan
	デジタル信号伝送方法、およびデジタル信号伝送装置	特開平 10-322388	Japan
デジタル信号伝送装置	特許 3133958	Japan	
OFDM波伝送装置	特許 3133960	Japan	
デジタル信号送信装置、およびデジタル信号受信装置	特開平 10-336158	Japan	
送信装置および受信装置	特開 2000-101543	Japan	
OFDM 伝送システムの AC 送受信装置方法および送信装置、受信装置 <small>Note 1</small>	特開 2002-9727	Japan	

Patent Applicant/ Holder	Name of Patent	Registration No./ Application No.	Remarks
Japan Broadcasting Corporation (NHK)	デジタル信号受信装置	特許 2975932	Japan
	直交周波数分割多重伝送方式とその送信装置及び受信装置	特許 3083159	Japan
	Orthogonal Frequency-division	98800917.X	China

ARIB STD – B31  
Version 1.6-E2

Patent Applicant/ Holder	Name of Patent	Registration No./ Application No.	Remarks
Next-generation Digital Television Broadcasting System Laboratory	Multiplex Transmission System, and its Transmitter and Receiver 直交周波数分割多重伝送方式とその送信装置及び受信装置	1999-7001638	Korea
		087110598	Taiwan
		特開 2000-236313	Japan
Victor Company of Japan, Ltd.	直交周波数分割多重信号送受信装置 直交周波数分割多重信号送受信装置 直交周波数分割多重信号送受信装置 直交周波数分割多重信号送受信装置 直交周波数分割多重信号の送受信システム	特許 2790239	Japan, United States, Germany, France, United Kingdom
		特許 2874729	Japan, United States
		特許 3055540	Japan
		特許 3055541	Japan
		特開 2000-224142	Japan
Sony Corporation*	Submitted comprehensive confirmation of patents for ARIB STD-B31 Ver1.1		
SANYO Electric Co., Ltd.*	再多重化装置および再多重化方法	特許 3216531	Japan

TOSHIBA Corporation*	デジタル放送システム、デジタル放送演奏所装置	特開 2000-32410	Japan
TOSHIBA AVE Corporation*			
Motorola Japan Ltd.* <sup>1</sup>	Submitted comprehensive confirmation of patents for ARIB STD-B31 Ver1.3		
Motorola Japan Ltd.* <sup>2</sup>	Submitted comprehensive confirmation of patents for ARIB STD-B31 Ver1.5		
Matsushita Electric Industrial Co., Ltd.* <sup>2</sup>	Submitted comprehensive confirmation of patents for ARIB STD-B31 Ver1.5		

\* : valid for the revised parts of ARIB STD-B31 Ver1.1 (received on November 8, 2001)

\*1 : valid for the revised parts of ARIB STD-B31 Ver1.3 (received on January 22, 2003)

Note 1 : those received at the time of ARIB STD-B31 revision to Ver1.4 (May 14, 2003)

\*2 : valid for the revised parts of ARIB STD-B31 Ver1.5 (received on July 22, 2003)

# Transmission System for Digital Terrestrial Television Broadcasting

<Blank Page>

# Transmission System for Digital Terrestrial Television Broadcasting

## Contents

Chapter 1: General Terms .....	5
1.1 Objective.....	5
1.2 Scope.....	5
1.3 References .....	5
1.3.1 Normative documents.....	5
1.3.2 Related documents.....	5
1.4 Terminology.....	6
1.4.1 Definitions .....	6
1.4.2 Abbreviations .....	8
Chapter 2: ISDB-T Overview .....	9
2.1 Hierarchical transmission.....	9
2.2 Partial reception .....	10
2.3 Modes.....	10
Chapter 3: Channel-Coding Scheme.....	11
3.1 Basic configuration of the channel coding .....	16
3.2 TS re-multiplexing.....	17
3.2.1 Multiplex-frame configuration.....	17
3.2.2 Model receiver for forming multiplex frame patterns.....	19
3.2.2.1 Input signals to the hierarchical divider.....	19
3.2.2.2 Operation of the model receiver from the hierarchical divider to the Viterbi decoding input.....	20
3.3 Outer code .....	21
3.4 Division of TS into hierarchical layers.....	22
3.5 Energy dispersal .....	23
3.6 Delay adjustment .....	24
3.7 Byte interleaving .....	25
3.8 Inner code.....	26
3.9 Carrier modulation.....	27

3.9.1	Configuration of the carrier modulator.....	27
3.9.2	Delay adjustment.....	27
3.9.3	Bit interleaving and mapping.....	28
3.9.3.1	DQPSK.....	28
3.9.3.3	16QAM.....	30
3.9.3.4	64QAM.....	31
3.9.4	Modulation-level normalization.....	32
3.9.5	Data-segment configuration.....	32
3.10	Combining hierarchical layers .....	34
3.11	Time and frequency interleaving.....	35
3.11.1	Time interleaving.....	35
3.11.2	Frequency interleaving.....	37
3.11.2.1	Inter-segment interleaving.....	38
3.11.2.2	Intra-segment interleaving.....	39
3.12	Frame structure.....	43
3.12.1	OFDM-segment configuration for the differential modulation.....	43
3.12.2	OFDM-segment configuration for the synchronous modulation.....	47
3.13	Pilot signals.....	49
3.13.1	Scattered pilot (SP).....	49
3.13.2	Continual pilot (CP).....	50
3.13.3	TMCC.....	50
3.13.4	AC (Auxiliary Channel).....	50
3.14	Transmission spectrum configuration.....	52
3.14.1	RF-signal format.....	53
3.14.2	Insertion of a guard interval.....	54
3.15	TMCC signal (Transmission and Multiplexing Configuration Control).....	54
3.15.1	Overview.....	54
3.15.2	Assignment of TMCC carrier bits.....	54
3.15.3	References for differential demodulation.....	55
3.15.4	Synchronizing signal .....	55
3.15.5	Segment type identification .....	55

3.15.6	TMCC information.....	56
3.15.6.1	System identification.....	57
3.15.6.2	Indicator of transmission-parameter switching.....	58
3.15.6.3	Start flag for emergency-alarm broadcasting.....	59
3.15.6.4	Partial-reception flag.....	59
3.15.6.5	Carrier modulation scheme.....	60
3.15.6.6	Convolutional-coding rate.....	61
3.15.6.7	Interleaving length.....	61
3.15.6.8	Number of segments.....	62
3.15.6.9	Channel-coding scheme.....	62
3.15.6.10	Modulation scheme.....	63
Chapter 4:	Frequency Utilization Requirements.....	64
4.1	Frequency bandwidth.....	64
4.2	Permissible transmission-frequency deviation.....	64
4.3	IFFT sampling frequency and permissible deviation.....	64
4.4	Transmission-spectrum mask.....	65
4.5	Maximum permitted power level of spurious emission or unwanted emission.....	66

<Blank Page>

## Chapter 1: General Terms

### 1.1 Objective

The purpose of this standard is to define the transmission system for digital terrestrial television broadcasting among various types of standard television broadcasting handled by broadcasting stations.

### 1.2 Scope

This standard applies to digital terrestrial television broadcasting using UHF and VHF bands. For details on the source coding-scheme and multiplexing-scheme standards among those related to digital terrestrial television broadcasting, see relevant standards.

### 1.3 References

#### 1.3.1 Normative documents

The following documents are those from which excerpts included in this standard were taken:

- “Ministerial ordinance for amending the entire standard transmission system for digital broadcasting among standard television broadcasting and the like (Ordinance No. 26 of the Ministry of Public Management, Home Affairs, Posts and Telecommunications, 2003)” (hereinafter referred to as “ordinance”), and “Notification of the Ministry of Public Management, Home Affairs, Posts and Telecommunications (Notification No. 37 of the Ministry of Public Management, Home Affairs, Posts and Telecommunications, 2003)” (hereinafter referred to as “notification”) related to the above ordinance
- “Rules for radio facilities (Regulation No. 18 of the Radio Regulatory Committee, 1950)” (hereinafter referred to as “ordinance”)

#### 1.3.2 Related documents

The following are the standards and other documents related to the transmission of digital terrestrial television broadcasting based on this standard:

- “Service Information for Digital Broadcasting System,” ARIB Standard, ARIB STD-B10
- “Data Coding and Transmission Specification for Digital Broadcasting,” ARIB Standard, ARIB STD-B24
- “Access Control System Specifications for Digital Broadcasting,” ARIB Standard, ARIB STD-B25
- “Video Coding, Audio Coding and Multiplexing Specifications for Digital Broadcasting,” ARIB Standard, ARIB STD-B32
- “Transmission System for Digital Terrestrial Sound Broadcasting,” ARIB Standard, ARIB STD-B29

## 1.4 Terminology

### 1.4.1 Definitions

Data segment:	Data group that corresponds to the effective carrier. This is an elementary block for channel coding.
OFDM segment:	Basic band (1/14 of television-channel bandwidth) for transmission signals, generated by adding control-signal carriers to data carriers. OFDM segment also means signal processed to make up a frame.
Partial reception:	Reception of only one OFDM segment at the center of a group of segments
Mode:	Identification of transmission mode based on the spacings between OFDM carrier frequencies
IFFT:	Inverse Fast Fourier Transform
ISDB-T:	Digital terrestrial television broadcasting system in which transmission bands consist of 13 OFDM segments
ISDB-T <sub>SB</sub> :	Digital terrestrial sound broadcasting system in which transmission bands consist of one or three OFDM segments
OFDM symbol:	Transmission symbol for the OFDM transmission signal
OFDM frame:	Transmission frame consisting of 204 OFDM symbols
Multiplex frame:	Frame that is provided for signal-processing purposes and is used to re-multiplex MPEG-2 TSs to create a single TS. This frame is identical to an OFDM frame in terms of duration.
Model receiver:	Virtual receiver used to arrange transmission TSPs on a multiplex frame
Carrier symbol:	A symbol per OFDM carrier
Segment number:	Number used to identify 13 OFDM segments and their corresponding data segments
Subchannel number:	ISDB-T <sub>SB</sub> tuning step with a virtual bandwidth of 1/7 MHz
Connected signal transmission:	A type of transmission of ISDB-T <sub>SB</sub> signals arranged without a guard band
Constraint length:	Number obtained by adding 1 to the number of delay elements in a convolutional coder
Hierarchical transmission:	Simultaneous transmission of multiple OFDM segments that are channel-coded differently
Hierarchical layer information:	Channel-coding parameter information on each layer in hierarchical transmission
Control information:	Information other than MPEG-2 TS that assists the receiver in demodulation and decoding operations
Additional information:	Information for non-broadcasting purposes that is transmitted using part of the control information carrier
Transmission TSP:	204-byte packet formed by adding 16-byte parity to 188-byte MPEG-2 TSP
Spurious emission	Emission on a frequency or frequencies which are outside the necessary bandwidth and the level of which may be reduced without affecting the corresponding transmission of information. Spurious emissions include harmonic emissions, parasitic emissions, intermodulation products and frequency conversion products, but exclude out-of-band emissions.

Out-of-band emission	Emission on a frequency or frequencies immediately outside the necessary bandwidth resulting from the modulation process, but excluding spurious emissions.
Unwanted emissions	Consist of spurious emission and out-of-band emissions.
Spurious domain	The frequency range beyond the out-of-band domain in which spurious emissions generally predominate.
Out-of-band domain	The frequency range, immediately outside the necessary bandwidth but excluding the spurious domain, in which out-of-band emissions generally predominate. In the case of digital terrestrial television broadcasting, the out-of-band domain is within +/-15 MHz from the center frequency of the necessary bandwidth (the frequency of the boundary between the out-of-band and spurious domain is included in the spurious domain).
Necessary bandwidth	A 6-MHz-wide frequency band in the case of digital terrestrial television broadcasting.

## 1.4.2 Abbreviations

AC:	Auxiliary Channel
CP:	Continual Pilot
DBPSK:	Differential Binary Phase Shift Keying
DQPSK:	Differential Quadrature Phase Shift Keying
IF:	Intermediate frequency
IFFT:	Inverse Fast Fourier Transform
ISDB:	Integrated Services Digital Broadcasting
ISDB-T:	ISDB for Terrestrial Television Broadcasting
ISDB-T <sub>SB</sub> :	ISDB for Terrestrial Sound Broadcasting
MPEG:	Moving Picture Experts Group
OCT:	Octal notation
OFDM:	Orthogonal Frequency Division Multiplexing
PRBS:	Pseudo-Random Binary Sequence
QAM:	Quadrature Amplitude Modulation
QPSK:	Quadrature Phase Shift Keying
RF:	Radio frequency
RS:	Reed-Solomon
SP:	Scattered Pilot
SFN:	Single Frequency Network
TMCC:	Transmission and Multiplexing Configuration Control
TSP:	Transport Stream Packet

## Chapter 2: ISDB-T Overview

With ISDB-T, one or more transport stream (TS) inputs, defined in “MPEG-2 Systems,” are re-multiplexed to create a single TS. This TS is then subjected to multiple channel-coding steps in accordance with the intentions of the service, and is finally sent as a single OFDM signal. ISDB-T also offers time interleaving to provide powerful channel coding for mobile-reception in which variations in field strength are inevitable.

The transmission spectrum of television broadcasting consists of 13 successive OFDM blocks (hereinafter referred to as “OFDM segments”), each bandwidth of which is equal to one fourteenth of a television-broadcasting channel bandwidth. An OFDM-segment carrier configuration that allows connection of multiple segments makes it possible to provide a transmission bandwidth appropriate in terms of units of segment width for the target media, while at the same time enabling use of the same receiver for both ISDB-T and ISDB-T<sub>SB</sub> (see “Transmission System for Digital Terrestrial Sound Broadcasting,” ARIB Standard, ARIB STD-B29).

### 2.1 Hierarchical transmission

Channel coding is conducted in units of OFDM segments. Therefore, part of a single television channel can be used for fixed-reception service and the rest for mobile-reception service. Such signal transmission is defined as hierarchical transmission. Each hierarchical layer consists of one or more OFDM segments, and parameters such as the carrier modulation scheme, inner-code coding rate, and time interleaving length can be specified for each hierarchical layer. Note that up to three hierarchical layers can be provided and that the segment used for partial reception, which will be discussed later, is also counted as one hierarchical layer.

The number of segments and the set of channel-coding parameters for each hierarchical layer are determined in accordance with the organization information. Note that TMCC signals convey control information that assists in receiver operations.

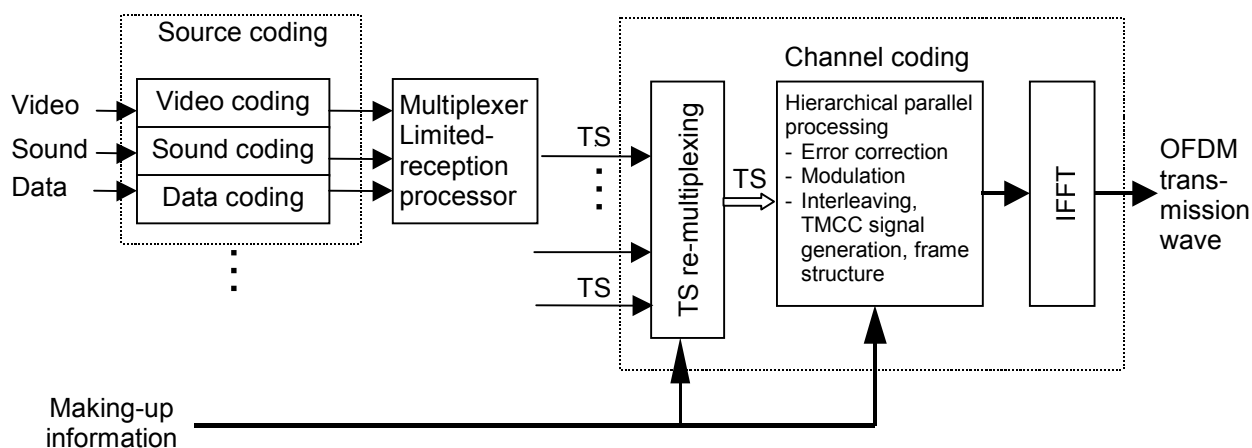

Fig. 2-1: ISDB-T Overview

## 2.2 Partial reception

As for an OFDM segment at the center of a television-broadcasting signal consisting of 13 segments, it is possible to conduct channel coding such that the range of frequency interleaving is limited within the segment. This configuration enables an ISDB-T<sub>SB</sub> receiver to receive one-segment service embedded in a hierarchical television signal(see “Channel Coding Scheme” in Chapter 3).

## 2.3 Modes

In consideration of the suitability of the distance between SFN stations and the robustness to Doppler shift during mobile-reception, ISDB-T offers three different spacings between OFDM carrier frequencies. These spacings are identified as system modes. The available spacings between OFDM carrier frequencies are approximately 4 kHz, 2 kHz, and 1 kHz in modes 1, 2, and 3, respectively.

The number of carriers used varies depending on the mode, but the information bit rate that can be transmitted remains the same in all modes.

## Chapter 3: Channel-Coding Scheme

Data transmitted through ISDB-T consists of a group of data (hereinafter referred to as “data segments”) that includes multiple TSPs (transport-stream packets) defined in “MPEG-2 Systems.” These data segments are subjected to required channel coding. Further, pilot signals are added to data segments in the OFDM framing section to form an OFDM segment (with a bandwidth of 6/14 MHz). A total of 13 OFDM segments are converted to OFDM transmission signals collectively by IFFT.

This channel-coding scheme allows hierarchical transmission in which multiple hierarchical layers with different transmission parameters can be transmitted simultaneously. Each hierarchical layer consists of one or more OFDM segments. Parameters such as the carrier modulation scheme, inner-code coding rate, and time interleaving length can be specified for each hierarchical layer.

In the configuration that contains one-segment service, a center OFDM segment of TV signal can be also received by a digital sound broadcasting receiver.

Note that up to three hierarchical layers can be transmitted.

Fig. 3-1 shows conceptual drawings of hierarchical transmission and partial reception. In addition, Tables 3-1 and 3-2 present OFDM segment transmission parameters identified as system modes and transmission signal parameters, respectively.

Note also that Table 3-3 shows the data rate per segment, while Table 3-4 presents the total data rate for all 13 segments.

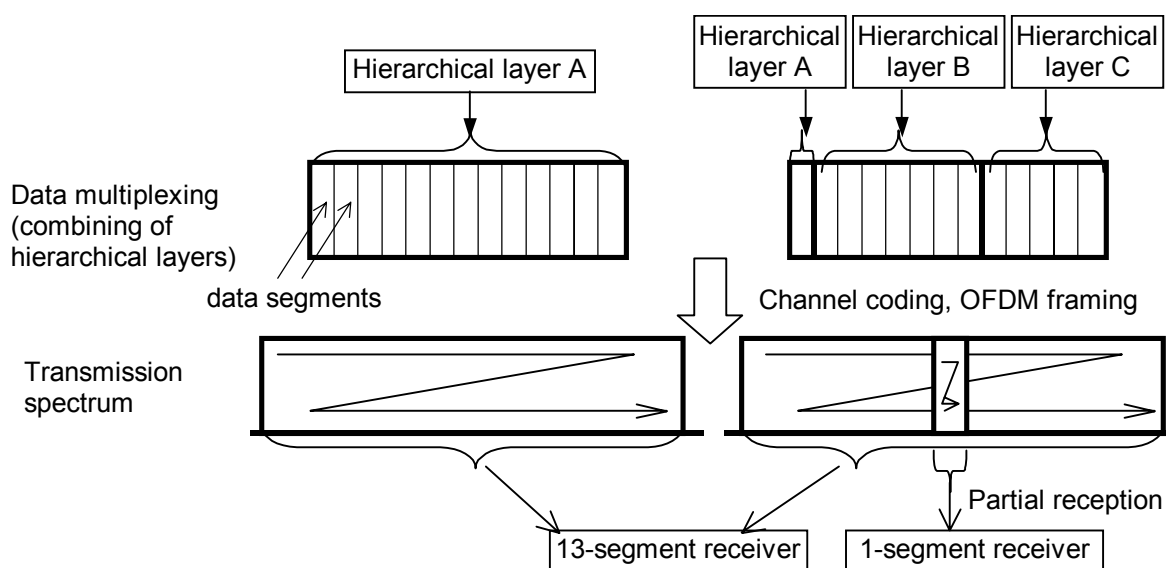

Fig. 3-1: Hierarchical Transmission and Partial Reception in Digital Terrestrial Television Broadcasting

Table 3-1: OFDM-Segment Parameters

Mode		Mode 1		Mode 2		Mode 3	
Bandwidth		3000/7 = 428.57... kHz					
Spacing between carrier frequencies		250/63 = 3.968... kHz		125/63 = 1.9841... kHz		125/126 = 0.99206... kHz	
Number of carriers	Total count	108	108	216	216	432	432
	Data	96	96	192	192	384	384
	SP*1	9	0	18	0	36	0
	CP*1	0	1	0	1	0	1
	TMCC*2	1	5	2	10	4	20
	AC1*3	2	2	4	4	8	8
	AC2*3	0	4	0	9	0	19
Carrier modulation scheme		QPSK 16QAM 64QAM	DQPSK	QPSK 16QAM 64QAM	DQPSK	QPSK 16QAM 64QAM	DQPSK
Symbols per frame		204					
Effective symbol length		252 μs		504 μs		1008 μs	
Guard interval		63 μs (1/4), 31.5 μs (1/8), 15.75 μs (1/16), 7.875 μs (1/32)		126 μs (1/4), 63 μs (1/8), 31.5 μs (1/16), 15.75 μs (1/32)		252 μs (1/4), 126 μs (1/8), 63 μs (1/16), 31.5 μs (1/32)	
Frame length		64.26 ms (1/4), 57.834 ms (1/8), 54.621 ms (1/16), 53.0145 ms (1/32)		128.52 ms (1/4), 115.668 ms (1/8), 109.242 ms (1/16), 106.029 ms (1/32)		257.04 ms (1/4), 231.336 ms (1/8), 218.484 ms (1/16), 212.058 ms (1/32)	
IFFT sampling frequency		512/63 = 8.12698... MHz					
Inner code		Convolutional code (1/2, 2/3, 3/4, 5/6, 7/8)					
Outer code		RS (204,188)					

\*1: SP (Scattered Pilot) and CP (Continual Pilot) are used by the receiver for synchronization and demodulation purposes.

\*2: TMCC (Transmission and Multiplexing Configuration Control) is control information.

\*3: AC (Auxiliary Channel) is used to transmit additional information. AC1 is available in an equal number in all segments, while AC2 is available only in differential modulated segments.

Table 3-2: Transmission-Signal Parameters

Mode		Mode 1	Mode 2	Mode 3
Number of OFDM segments $N_s$		13		
Bandwidth		$3000/7 \text{ (kHz)} \times N_s + 250/63 \text{ (kHz)}$ $= 5.575 \dots \text{MHz}$	$3000/7 \text{ (kHz)} \times N_s + 125/63 \text{ (kHz)}$ $= 5.573 \dots \text{MHz}$	$3000/7 \text{ (kHz)} \times N_s + 125/126 \text{ (kHz)}$ $= 5.572 \dots \text{MHz}$
Number of segments of differential modulations		$n_d$		
Number of segments of synchronous modulations		$n_s \text{ (} n_s + n_d = N_s \text{)}$		
Spacings between carrier frequencies		$250/63 = 3.968 \dots \text{kHz}$	$125/63 = 1.984 \dots \text{kHz}$	$125/126 = 0.992 \dots \text{kHz}$
Number of carriers	Total count	$108 \times N_s + 1 = 1405$	$216 \times N_s + 1 = 2809$	$432 \times N_s + 1 = 5617$
	Data	$96 \times N_s = 1248$	$192 \times N_s = 2496$	$384 \times N_s = 4992$
	SP	$9 \times n_s$	$18 \times n_s$	$36 \times n_s$
	CP*1	$n_d + 1$	$n_d + 1$	$n_d + 1$
	TMCC	$n_s + 5 \times n_d$	$2 \times n_s + 10 \times n_d$	$4 \times n_s + 20 \times n_d$
	AC1	$2 \times N_s = 26$	$4 \times N_s = 52$	$8 \times N_s = 104$
	AC2	$4 \times n_d$	$9 \times n_d$	$19 \times n_d$
Carrier modulation scheme		QPSK, 16QAM, 64QAM, DQPSK		
Symbols per frame		204		
Effective symbol length		252 $\mu\text{s}$	504 $\mu\text{s}$	1.008 ms
Guard interval		63 $\mu\text{s}$ (1/4), 31.5 $\mu\text{s}$ (1/8), 15.75 $\mu\text{s}$ (1/16), 7.875 $\mu\text{s}$ (1/32)	126 $\mu\text{s}$ (1/4), 63 $\mu\text{s}$ (1/8), 31.5 $\mu\text{s}$ (1/16), 15.75 $\mu\text{s}$ (1/32)	252 $\mu\text{s}$ (1/4), 126 $\mu\text{s}$ (1/8), 63 $\mu\text{s}$ (1/16), 31.5 $\mu\text{s}$ (1/32)
Frame length		64.26 ms (1/4), 57.834 ms (1/8), 54.621 ms (1/16), 53.0145 ms (1/32)	128.52 ms (1/4), 115.668 ms (1/8), 109.242 ms (1/16), 106.029 ms (1/32)	257.04 ms (1/4), 231.336 ms (1/8), 218.484 ms (1/16), 212.058 ms (1/32)
Inner code		Convolutional code (1/2, 2/3, 3/4, 5/6, 7/8)		
Outer code		RS (204,188)		

\*1: The number of CPs represents the sum of those CPs in segments, plus one CP added to the right of the entire bandwidth.

Table 3-3: Data Rate of a Single Segment

Carrier modulation	Convolutional code	Number of TSPs transmitted *1 (Mode 1/2/3)	Data rate (kbps) *2			
			Guard ratio: 1/4	Guard ratio: 1/8	Guard ratio: 1/16	Guard ratio: 1/32
DQPSK	1/2	12/24/48	280.85	312.06	330.42	340.43
	2/3	16/32/64	374.47	416.08	440.56	453.91
QPSK	3/4	18/36/72	421.28	468.09	495.63	510.65
	5/6	20/40/80	468.09	520.10	550.70	567.39
	7/8	21/42/84	491.50	546.11	578.23	595.76
16QAM	1/2	24/48/96	561.71	624.13	660.84	680.87
	2/3	32/64/128	748.95	832.17	881.12	907.82
	3/4	36/72/144	842.57	936.19	991.26	1021.30
	5/6	40/80/160	936.19	1040.21	1101.40	1134.78
	7/8	42/84/168	983.00	1092.22	1156.47	1191.52
64QAM	1/2	36/72/144	842.57	936.19	991.26	1021.30
	2/3	48/96/192	1123.43	1248.26	1321.68	1361.74
	3/4	54/108/216	1263.86	1404.29	1486.90	1531.95
	5/6	60/120/240	1404.29	1560.32	1652.11	1702.17
	7/8	63/126/252	1474.50	1638.34	1734.71	1787.28

\*1: Represents the number of TSPs transmitted per frame

\*2: Represents the data rate (bits) per segment for transmission parameters

Data rate (bits): TSPs transmitted × 188 (bytes/TSP) × 8 (bits/byte) × 1/frame length

Table 3-4: Total Data Rate \*1

Carrier modulation	Convolutional code	Number of TSPs transmitted (Mode 1/2/3)	Data rate (Mbps)			
			Guard ratio: 1/4	Guard ratio: 1/8	Guard ratio: 1/16	Guard ratio: 1/32
DQPSK	1/2	156/312/624	3.651	4.056	4.295	4.425
	2/3	208/416/832	4.868	5.409	5.727	5.900
QPSK	3/4	234/468/936	5.476	6.085	6.443	6.638
	5/6	260/520/1040	6.085	6.761	7.159	7.376
	7/8	273/546/1092	6.389	7.099	7.517	7.744
16QAM	1/2	312/624/1248	7.302	8.113	8.590	8.851
	2/3	416/832/1664	9.736	10.818	11.454	11.801
	3/4	468/936/1872	10.953	12.170	12.886	13.276
	5/6	520/1040/2080	12.170	13.522	14.318	14.752
	7/8	546/1092/2184	12.779	14.198	15.034	15.489
64QAM	1/2	468/936/1872	10.953	12.170	12.886	13.276
	2/3	624/1248/2496	14.604	16.227	17.181	17.702
	3/4	702/1404/2808	16.430	18.255	19.329	19.915
	5/6	780/1560/3120	18.255	20.284	21.477	22.128
	7/8	819/1638/3276	19.168	21.298	22.551	23.234

\*1: This table shows an example of the total data rate in which the same parameters are specified for all 13 segments. Note that the total data rate during hierarchical transmission varies depending on the hierarchical parameter configuration. In the case shown above, the data volume transmitted by all 13 segments is equal to the sum of all data volumes transmitted by these segments that can be determined based on Table 3-3.

### 3.1 Basic configuration of the channel coding

Multiple TSs output by the MPEG-2 multiplexer are fed to the TS re-multiplexer such that TSPs can be properly arranged for signal processing one data segment at a time. In the re-multiplexer, each TS is first converted into 188-byte burst-signal form by means of a clock having a rate four times higher than that of the IFFT sample clock. An outer code is then applied, and these TSs are converted into a single TS.

When hierarchical transmission is performed, the TS is divided into multiple hierarchical layers in accordance with the hierarchy information. These layers are then fed to a maximum of three parallel-processor blocks.

In the parallel processor, digital data-processing steps including error-correction coding, interleaving, and carrier modulation are primarily conducted. Note also that the difference in delay time (generated in byte-interleaving and bit-interleaving signal processes) between hierarchical layers is adjusted in advance to adjust timing. Error correction, interleaving length, and the carrier modulation scheme are specified for one hierarchical layer independently.

Following parallel processing, hierarchical layer signals are combined and then fed to the time and frequency interleaving sections to ensure the improvement of error-correction effectively against both the variation of field strength and multipath interference in mobile-reception.

Convolutional interleaving is used as the time-interleaving scheme to reduce both transmission and reception delay times and minimize the receiver memory size. As for frequency interleaving, both inter-segment and intra-segment interleaving are employed to ensure the appropriate segment structure and proper interleaving.

To ensure that the receiver properly performs demodulation and decoding in hierarchical transmission in which multiple sets of transmission parameters are used, a TMCC (Transmission and Multiplexing Configuration Control) signal is also transmitted using specific carriers. The TMCC signal forms the OFDM frame together with program signals and pilot signals for synchronization and reproduction purposes. Once formation of a frame is complete, all signals are converted to OFDM transmission signals by IFFT process.

Fig. 3-2 shows the basic configuration of the channel coding.

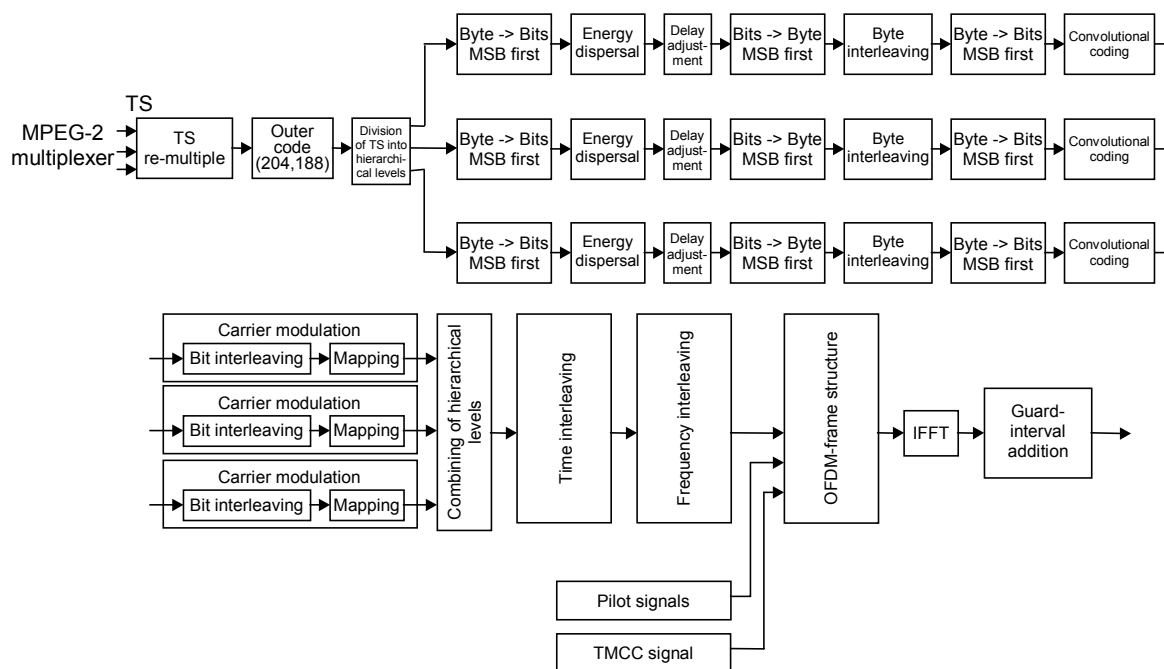

Fig. 3-2: Blocks Available in the Channel Coding

## 3.2 TS re-multiplexing

### 3.2.1 Multiplex-frame configuration

A re-multiplexed transport stream (TS) is formed by multiplex frames as elementary units, each of which consists of  $n$  pieces of transport-stream packets (TSPs). Table 3-5 shows the numbers of TSPs used for different transmission modes and guard-interval ratios.

Each of the TSPs comprising a multiplex frame is 204 bytes in length, consisting of 188-byte program data and 16-byte null data. This TSP is referred to as “transmission TSP.” The multiplex-frame length matches that of the OFDM frame when the clock rate for sending transmission TSP is increased to four times that of the IFFT sample clock rate.

As shown in Fig. 3-3, each of the transmission TSPs within a multiplex frame is transmitted by hierarchical layer  $X$  of an OFDM signal (layer  $X$  designates either layer A, B, or C) or belongs to a null packet (TSP<sub>null</sub>) that is not transmitted as an OFDM signal. The arrangement of transmission TSPs within a multiplex frame is determined in advance to ensure that it is identical to that of the TSs that will be reproduced by the model receiver shown in Fig. 3-4.

Table 3-5: Multiplex-Frame Configuration

Mode	Number of transmission TSPs included in one multiplex frame			
	Guard-interval ratio 1/4	Guard-interval ratio 1/8	Guard-interval ratio 1/16	Guard-interval ratio 1/32
Mode 1	1280	1152	1088	1056
Mode 2	2560	2304	2176	2112
Mode 3	5120	4608	4352	4224

(Ordinance)

Because the number of transport-stream packets that can be transmitted per unit time varies substantially depending on the parameters specified for each hierarchical layer, it is generally not possible to achieve consistency between TSs input to the re-multiplexer and a single TS output from it. However, the addition of an appropriate number of null packets allows interfacing between the transmitter and receiver during transmission of transport streams at a constant clock rate, regardless of which transmission parameters are specified.

Because multiplex-frame length is the same as OFDM-frame length, the receiver can reproduce transport-stream synchronization based on OFDM-signal synchronization, thus ensuring improved synchronization performance.

Correlating TSP arrangement within a multiplex frame with “division of TS into multiple hierarchical layers and combining of these layers” allows the receiving side to select the same single TS as the one transmitted from among multiple signals of different layers, and to reproduce that TS. For this reason, we define the model receiver operation on the transmitting side to indirectly stipulate TSP arrangement. The receiving side can reproduce TS without any TSP position information when it operates in the same manner as the model receiver.

Fig. 3-3 shows an example of a re-multiplexed transport stream.

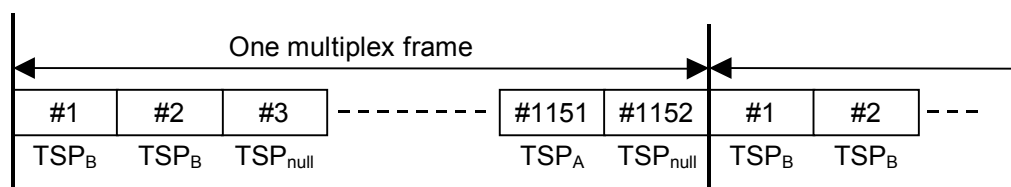

Fig. 3-3: Example of a Re-Multiplexed Transport Stream  
(Mode 1, Guard Interval of 1/8)

### 3.2.2 Model receiver for forming multiplex frame patterns

TSPs are arranged on a multiplex frame in accordance with the configuration of TS reproduced by the model receiver shown in Fig. 3-4. Note that an FFT sampling clock is used in this case.

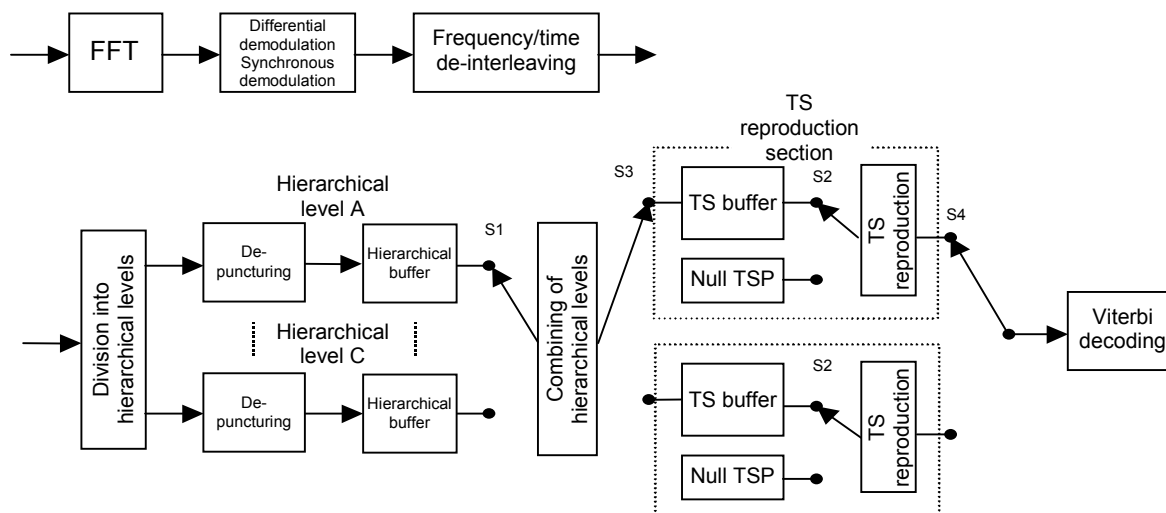

Fig. 3-4: Model Receiver for Forming Multiplex Frame Patterns

#### 3.2.2.1 Input signals to the hierarchical divider

Upon completion of processing such as carrier demodulation and de-interleaving, input signals to the hierarchical divider are arranged in ascending order of segment number, and also in ascending order of the carrier frequency of information symbol within a segment (obtained by excluding the carriers of control symbol). Fig. 3-5 shows an example in which two hierarchical layers are available (one layer modulated through DQPSK 1/2 with 5 segments, and the other modulated through 64QAM 7/8 with 8 segments), and a guard interval of 1/8 and mode 1 are selected.

During the period of one OFDM symbol, data the size of 480 ( $96 \times 5$ ) carriers is input to hierarchical layer A, followed by the input of data the size of 768 ( $96 \times 8$ ) carriers to hierarchical layer B and a null signal the size of 1056 carriers.

The null signal corresponds to the sum of sampling (equivalent to pilot signals inserted by the OFDM framing section), FFT sampling (sampling in excess of the net signal band), and guard-interval sampling. This operation is repeated as many times as 204 symbols for the duration of one OFDM frame.

Note that delays are adjusted such that the periods of time required for differential or synchronous demodulation become the same.

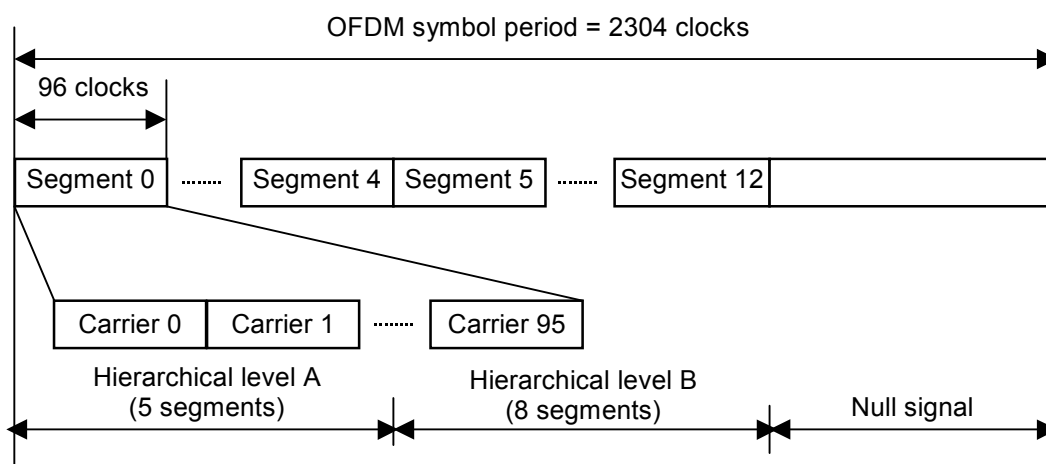

Fig. 3-5: Time Arrangement for Input Signals to Hierarchical Layers

### 3.2.2.2 Operation of the model receiver from the hierarchical divider to the Viterbi decoding input

Signal, divided into multiple hierarchical layers, is then subjected to de-puncturing before being stored in the hierarchical buffer. In this case, we assume that the processing delay time is the same for all layers, and that there is no delay time for the model receiver.

At this time, the number of bits  $B_{X,k}$  that are input to and stored in the hierarchical buffer upon input of the  $k$ th datum to hierarchical layer  $X$  in a single multiplex frame can be determined by the following formula:

$$B_{X,k} = 2 \times ([k \times S_x \times R_x] - [(k-1) \times S_x \times R_x])$$

where  $[ ]$  indicates that all digits to the right of the decimal point are discarded. Note that  $R_x$  represents the convolutional-code coding rate at hierarchical layer  $X$ . Note also that  $S_x$  takes one of the values given in Table 3-6, depending on the modulation scheme selected for hierarchical layer  $X$ .

Table 3-6:  $S_x$  Value

Modulation scheme	$S_x$
DQPSK/QPSK	2
16QAM	4
64QAM	6

Switch S1 is switched over to another hierarchical buffer when data the size of one TS packet (408 bytes\*) is input to the hierarchical buffer. This data is transferred to the TS buffer provided in the TS reproduction section. In this case, we assume that data transfer is instantaneous.

\* Convolutional coding of a single TS packet (204 bytes) of data produces 408 bytes, as the coding rate of the mother code of the convolutional code is 1/2.

The TS reproduction section checks the TS buffer every TS packet period (408 clocks). If there is more data than the size of one TS packet, this section switches S2 over to the TS buffer position and reads out one TS packet of data. When there is no data in the TS buffer, the TS reproduction section switches S2 over to the null TSP position and transmits a null packet.

Switch S3 is used to alternately switch between two TS reproduction sections for inputting a hierarchical combiner output signal. In mode 1, switching is performed at the beginning of an OFDM frame. Switch S4 is used to switch between TS reproduction-section signal outputs. This switch is switched over to the same position as S3 in three TS packet period (408 × 3 clocks) following the switching of S3, that is, at the beginning of an OFDM frame.

In modes 2 and 3, switching of S3 and S4 is performed at 1/2 OFDM-frame intervals (102 OFDM-symbol intervals) and 1/4 OFDM-frame intervals (51 OFDM-symbol intervals), respectively.

### 3.3 Outer code

A shortened Reed-Solomon code (204,188) is used in every TSP as an outer code. The shortened Reed-Solomon (204,188) code is generated by adding 51-byte 00HEX at the beginning of the input of the data bytes of Reed-Solomon (255,239) code, and then removing these 51 bytes.

The GF (2<sup>8</sup>) element is used as the Reed-Solomon code element. The following primitive polynomial p (x) is used to define GF (2<sup>8</sup>):

$$p(x) = x^8 + x^4 + x^3 + x^2 + 1$$

Note also that the following polynomial g (x) is used to generate (204,188) shortened Reed-Solomon code:

$$g(x) = (x - \lambda^0) (x - \lambda^1) (x - \lambda^2) \dots (x - \lambda^{15}) \text{ provided that } \lambda = 02 \text{ HEX}$$

(Ordinance)

[Description]

Shortened Reed-Solomon (204,188) code is the same as the outer code used for digital satellite broadcasting, and can correct up to 8 random bytes in error among 204 bytes.

Fig. 3-6 shows MPEG2 TSP and TSP that is error-protected by RS code. Note that the error-protected 204-byte packet is also called “transmission TSP.”

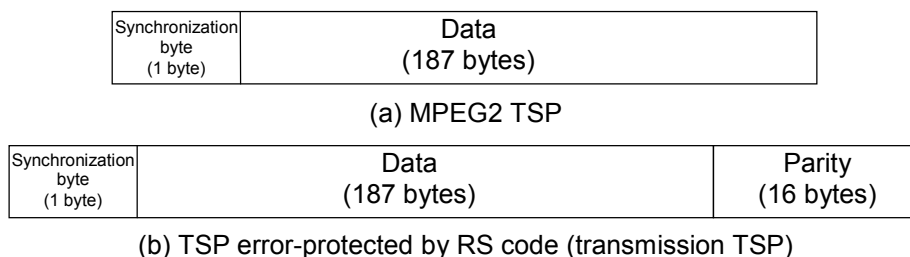

Fig. 3-6: MPEG2 TSP and Transmission TSP

### 3.4 Division of TS into hierarchical layers

The hierarchical divider divides re-multiplexed TS into multiple portions (transmission TSPs, each of which is 204 bytes in length, containing all bytes from the byte next to the TS synchronization byte to the next synchronization byte), and assigns each portion to the specified hierarchical layer. At the same time, the divider removes the null packet. The hierarchical layer to which each of the transmission TSPs belongs is specified by hierarchy information based on organization information. The maximum number of hierarchical layers must be three. Note also that OFDM-frame synchronization shifts by one byte, to the beginning of the information bytes.

Fig. 3-7 shows an example of the division of TS into two hierarchical layers.

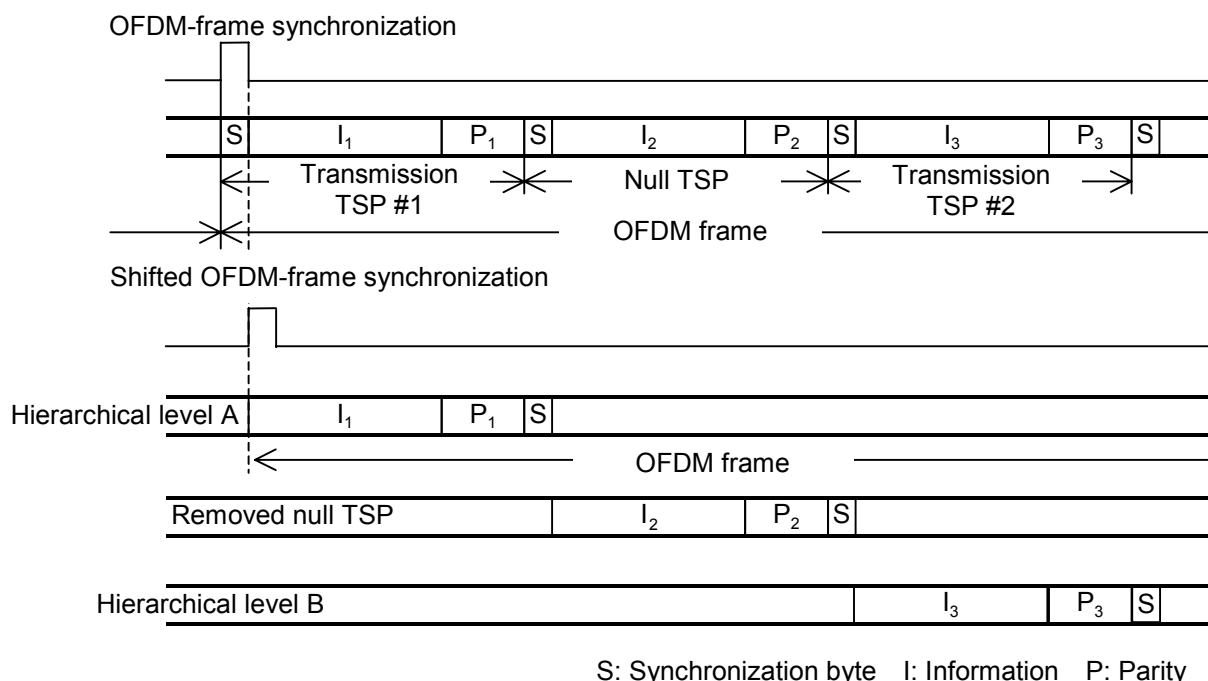

Fig. 3-7: Example of Hierarchical Divider Operation

### 3.5 Energy dispersal

Energy dispersal is conducted at each hierarchical layer using a circuit, shown in Fig. 3-8, that is generated by a PRBS (Pseudo Random Bit Sequence). All signals other than the synchronization byte in each of the transmission TSPs at different hierarchical layers are EXCLUSIVE ORed using PRBSs, on a bit-by-bit basis.

The initial value of the PRBS-generating circuit must be “100101010000000” (arranged in ascending order of bits, from left to right), and this value must be initialized every OFDM frame. At this time, the beginning of an OFDM frame must be the MSB of the byte next to the transmission TSP’s synchronization byte. Note also that the shift register must also perform shifting of the synchronization byte.

$$g(x) = X^{15} + X^{14} + 1$$

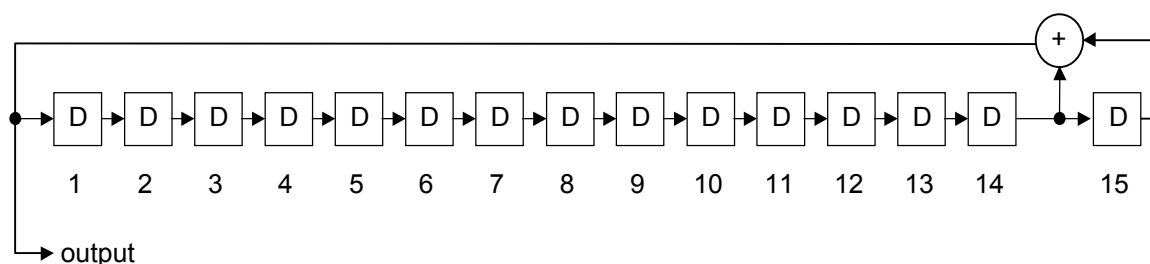

Fig. 3-8: PRBS-Generating Polynomial and Circuit

(Ordinance)

### 3.6 Delay adjustment

Delay adjustment associated with byte interleaving, intended to provide identical transmission and reception delay times for all hierarchical layers, is conducted on the transmitting side.

An appropriate adjustment value must be selected and specified for each hierarchical layer from among those (equivalent to the number of transmission TSPs) shown below, such that all delays, including transmission and reception delays caused by byte interleaving (11 transmission TSPs), are one frame in length.

Table 3-7: Delay-Adjustment Values Required as a Result of Byte Interleaving

Carrier modulation	Convolutional code	Delay-adjustment value (number of transmission TSPs)		
		Mode 1	Mode 2	Mode 3
DQPSK	1/2	$12 \times N-11$	$24 \times N-11$	$48 \times N-11$
	2/3	$16 \times N-11$	$32 \times N-11$	$64 \times N-11$
	3/4	$18 \times N-11$	$36 \times N-11$	$72 \times N-11$
QPSK	5/6	$20 \times N-11$	$40 \times N-11$	$80 \times N-11$
	7/8	$21 \times N-11$	$42 \times N-11$	$84 \times N-11$
16QAM	1/2	$24 \times N-11$	$48 \times N-11$	$96 \times N-11$
	2/3	$32 \times N-11$	$64 \times N-11$	$128 \times N-11$
	3/4	$36 \times N-11$	$72 \times N-11$	$144 \times N-11$
	5/6	$40 \times N-11$	$80 \times N-11$	$160 \times N-11$
	7/8	$42 \times N-11$	$84 \times N-11$	$168 \times N-11$
64QAM	1/2	$36 \times N-11$	$72 \times N-11$	$144 \times N-11$
	2/3	$48 \times N-11$	$96 \times N-11$	$192 \times N-11$
	3/4	$54 \times N-11$	$108 \times N-11$	$216 \times N-11$
	5/6	$60 \times N-11$	$120 \times N-11$	$240 \times N-11$
	7/8	$63 \times N-11$	$126 \times N-11$	$252 \times N-11$

N represents the number of segments used by that hierarchical layer.

(Ordinance)

With hierarchical transmission, it is possible to specify different sets of transmission parameters (number of segments, inner-code coding rate, modulation scheme) for different hierarchical layers. In this case, however, the transmission bit rate for one layer differs from that for another layer, resulting in different transmission capacities calculated as the time periods from coding of the inner code on the transmitting side to decoding on the receiving side.

Therefore, the amount of transmission TSP delay (11 TSPs) caused by byte interleaving (discussed later) for one layer differs from that for another layer when it is converted to delay time.

To compensate for this relative difference in delay time between hierarchical layers, delay adjustment is conducted at each layer prior to byte interleaving, in accordance with the transmission bit rate.

### 3.7 Byte interleaving

The 204-byte transmission TSP, which is error-protected by means of RS code and energy-dispersed, undergoes convolutional byte interleaving. Interleaving must be 12 bytes in depth. Note, however, that the byte next to the synchronization byte must pass through a reference path that causes no delay.

Fig. 3-9 shows the byte interleaving circuit.

In the intercode interleaving circuit, path 0 has no delay. The memory size for path 1 must be 17 bytes, that for path 2 be  $17 \times 2 = 34$  bytes, and so on. Input and output must be switched over to a different path every byte, in a sequential and cyclic manner, in ascending order of path number (path 0 -> path 1 -> path 2 ---- path 11 -> path 0 -> path 1 -> path 2).

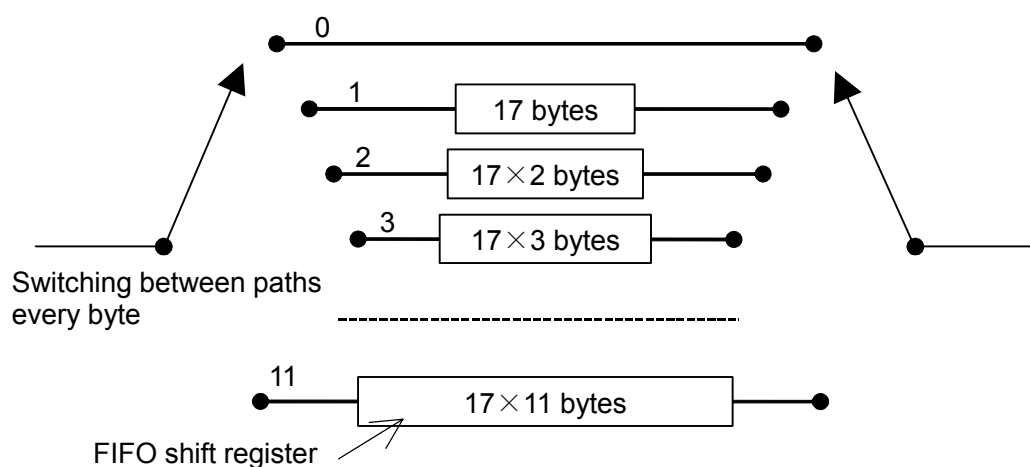

Fig. 3-9: Byte Interleaving Circuit

(Ordinance)

### 3.8 Inner code

The inner code is a punctured convolutional code with a mother code having a constraint length  $k$  of 7, and a coding rate of  $1/2$ . The generating polynomial of the mother code must be  $G_1 = 171_{\text{OCT}}$  and  $G_2 = 133_{\text{OCT}}$ . Fig. 3-10 shows the coding circuit of the original code with constraint length  $k$  of 7, and a coding rate of  $1/2$ .

Table 3-8 shows the selectable inner-code coding rates and transmission signal sequence that are punctured at that time. Note that the puncturing pattern must be reset such that the patterns shown in Table 3-8 are initiated by frame synchronization. This is intended to ensure improved receiver reliability in compensating for synchronization between puncturing patterns.

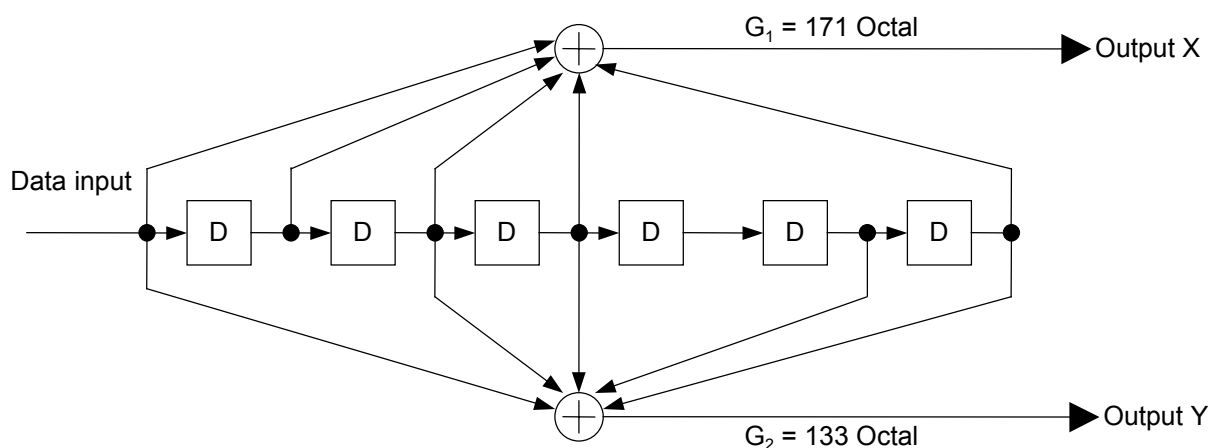

Fig. 3-10: Coding Circuit of a Convolutional Code with Constraint Length  $k$  of 7 and a Coding Rate of  $1/2$

Table 3-8: Inner-Code Coding Rates and Transmission-Signal Sequence

Coding rate	Puncturing pattern	Transmission-signal sequence
1/2	X : 1 Y : 1	X1, Y1
2/3	X : 1 0 Y : 1 1	X1, Y1, Y2
3/4	X : 1 0 1 Y : 1 1 0	X1, Y1, Y2, X3
5/6	X : 1 0 1 0 1 Y : 1 1 0 1 0	X1, Y1, Y2, X3, Y4, X5
7/8	X : 1 0 0 0 1 0 1 Y : 1 1 1 1 0 1 0	X1, Y1, Y2, Y3, Y4, X5, Y6, X7

(Ordinance)

### 3.9 Carrier modulation

#### 3.9.1 Configuration of the carrier modulator

In the carrier modulation process, the input signal is bit-interleaved and mapped through the schemes specified for each hierarchical layer. Fig. 3-11 shows the carrier-modulator configuration.

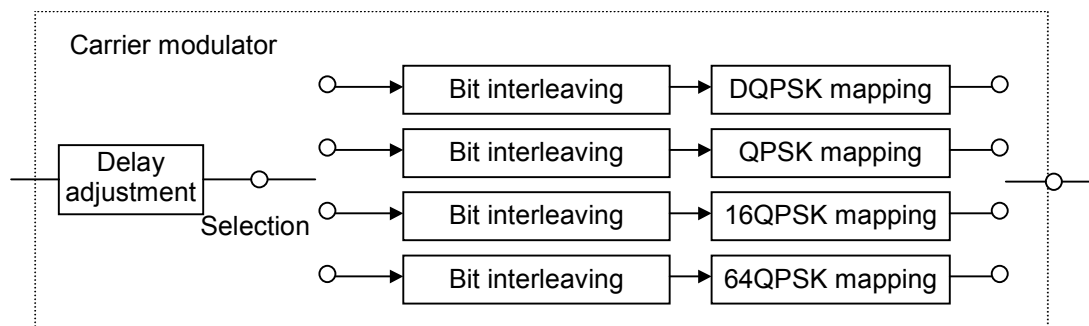

Fig. 3-11: Carrier-Modulator Configuration

#### 3.9.2 Delay adjustment

Transmission and reception delays equivalent to 120 carrier symbols occur as a result of bit interleaving of the carrier modulator. The delay time varies depending on the carrier modulation scheme, that is, the number of bits comprising the carrier symbol.

This difference in delay time is corrected at the bit interleaving input side through the addition of the delay-adjustment value shown in Table 3-9 such that the total transmission and reception delays are equal to 2 OFDM symbols.

Table 3-9: Delay-Adjustment Values Required as a Result of Bit Interleaving

Carrier modulation	Delay-adjustment value (number of bits)		
	Mode 1	Mode 2	Mode 3
DQPSK QPSK	$384 \times N-240$	$768 \times N-240$	$1536 \times N-240$
16QAM	$768 \times N-480$	$1536 \times N-480$	$3072 \times N-480$
64QAM	$1152 \times N-720$	$2304 \times N-720$	$4608 \times N-720$

N represents the number of segments used by that hierarchical layer.

(Ordinance)

### 3.9.3 Bit interleaving and mapping

#### 3.9.3.1 DQPSK

The input signal must be 2 bits per symbol and p/4-shift DQPSK-mapped to output multi-bit I- and Q-axes data. Upon completion of serial-parallel conversion, the 120-bit delay element shown in Fig. 3-12 is inserted into the phase-calculator input for bit interleaving. Figs. 3-12 and 3-13 show the system diagram and mapping constellation, respectively.

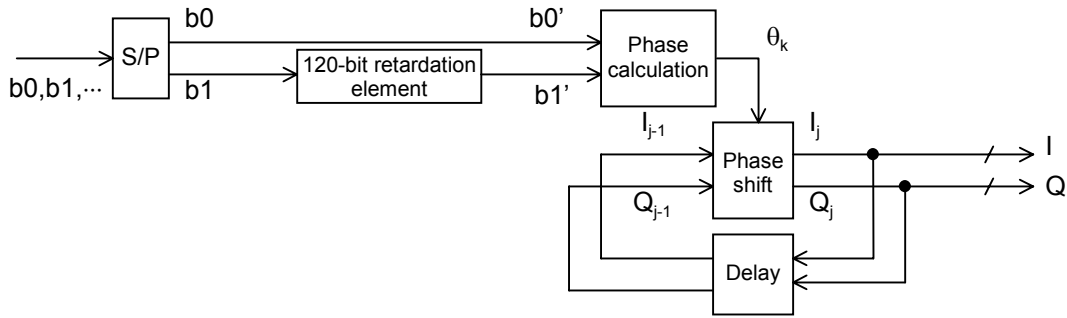

Fig. 3-12:  $\pi/4$ -Shift DQPSK Modulation System Diagram

Table 3-10: Phase Calculation

input b0' b1'	output $\theta_j$
0 0	$\pi/4$
0 1	$-\pi/4$
1 0	$3\pi/4$
1 1	$-3\pi/4$

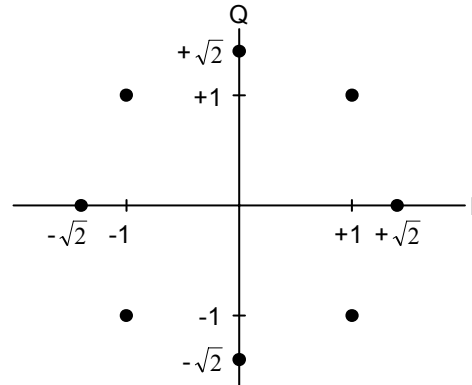

Fig. 3-13:  $\pi/4$ -Shift DQPSK Constellation

The following shows the phase shift:

$$\begin{pmatrix} I_j \\ Q_j \end{pmatrix} = \begin{pmatrix} \cos \theta_j & -\sin \theta_j \\ \sin \theta_j & \cos \theta_j \end{pmatrix} \begin{pmatrix} I_{j-1} \\ Q_{j-1} \end{pmatrix}$$

Provided that  $(I_j, Q_j)$  and  $(I_{j-1}, Q_{j-1})$  represent the output symbol and the OFDM symbol immediately preceding the output symbol, respectively

(Ordinance)

### 3.9.3.2 QPSK

The input signal must be 2 bits per symbol and QPSK-mapped to output multi-bit I- and Q-axes data. To conduct mapping, the 120-bit delay element shown in Fig. 3-14 is inserted into the mapping input for bit interleaving.

Figs. 3-14 and 3-15 show the system diagram and mapping constellation, respectively.

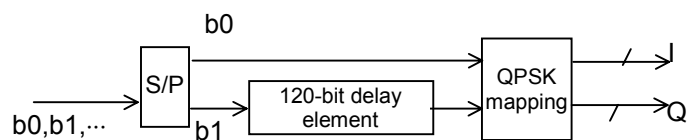

Fig. 3-14: QPSK Modulation System Diagram

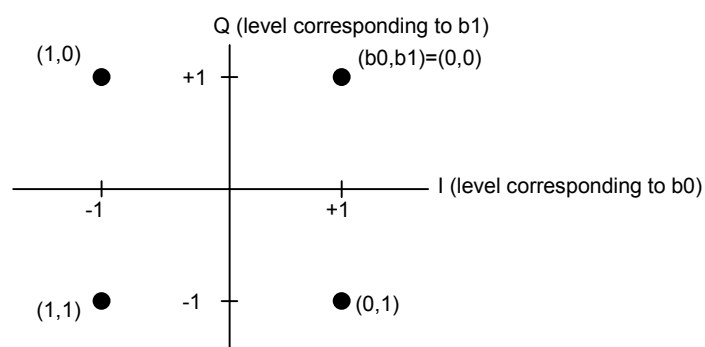

Fig. 3-15: QPSK Constellation

(Ordinance)

### 3.9.3.3 16QAM

The input signal must be 4 bits per symbol and 16QAM-mapped to output multi-bit I- and Q-axes data. To conduct mapping, the delay elements shown in Fig. 3-16 are inserted into b1 to b3 for bit interleaving.

Figs. 3-16 and 3-17 show the system diagram and mapping constellation, respectively.

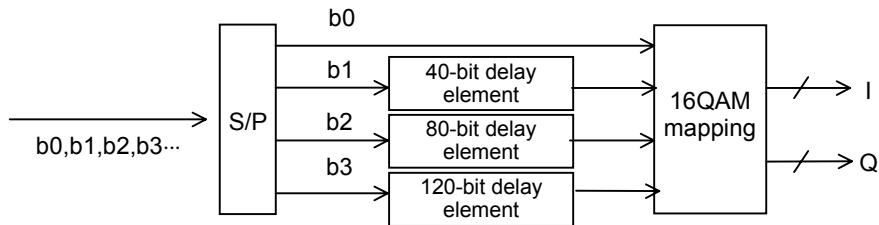

Fig. 3-16: 16QAM Modulation System Diagram

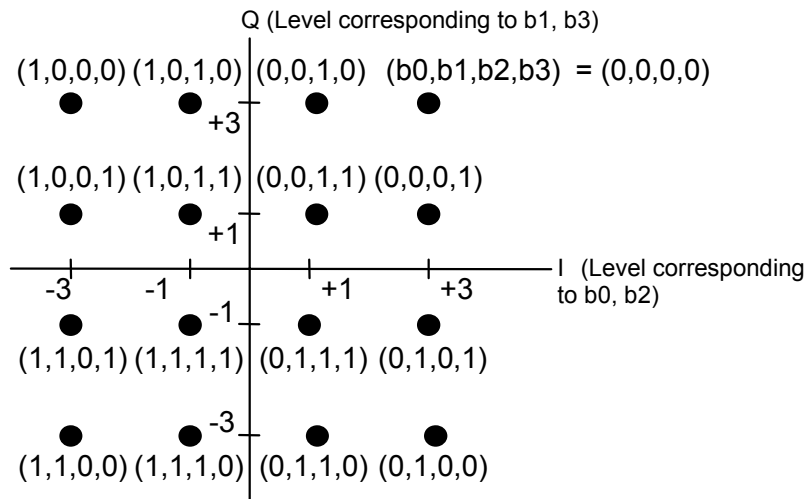

Fig. 3-17: 16QAM Constellation

(Ordinance)

### 3.9.3.4 64QAM

The input signal must be 6 bits per symbol and 64QAM-mapped to output multi-bit I- and Q-axes data. To conduct mapping, the delay elements shown in Fig. 3-18 are inserted into b1 to b5 for bit interleaving.

Figs. 3-18 and 3-19 show the system diagram and mapping constellation, respectively.

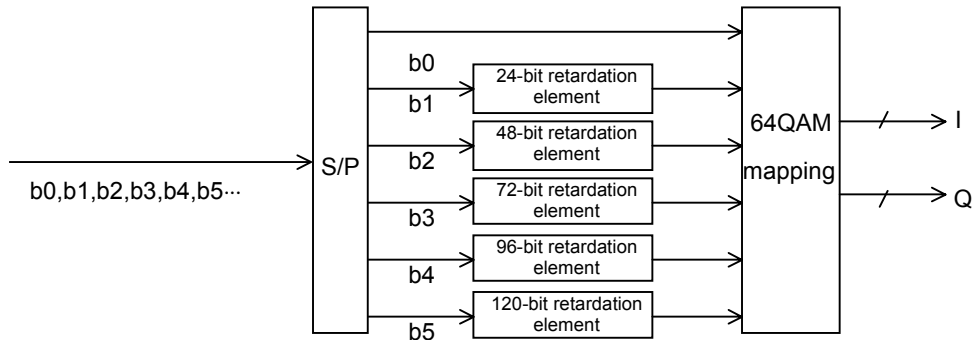

Fig. 3-18: 64QAM Modulation System Diagram

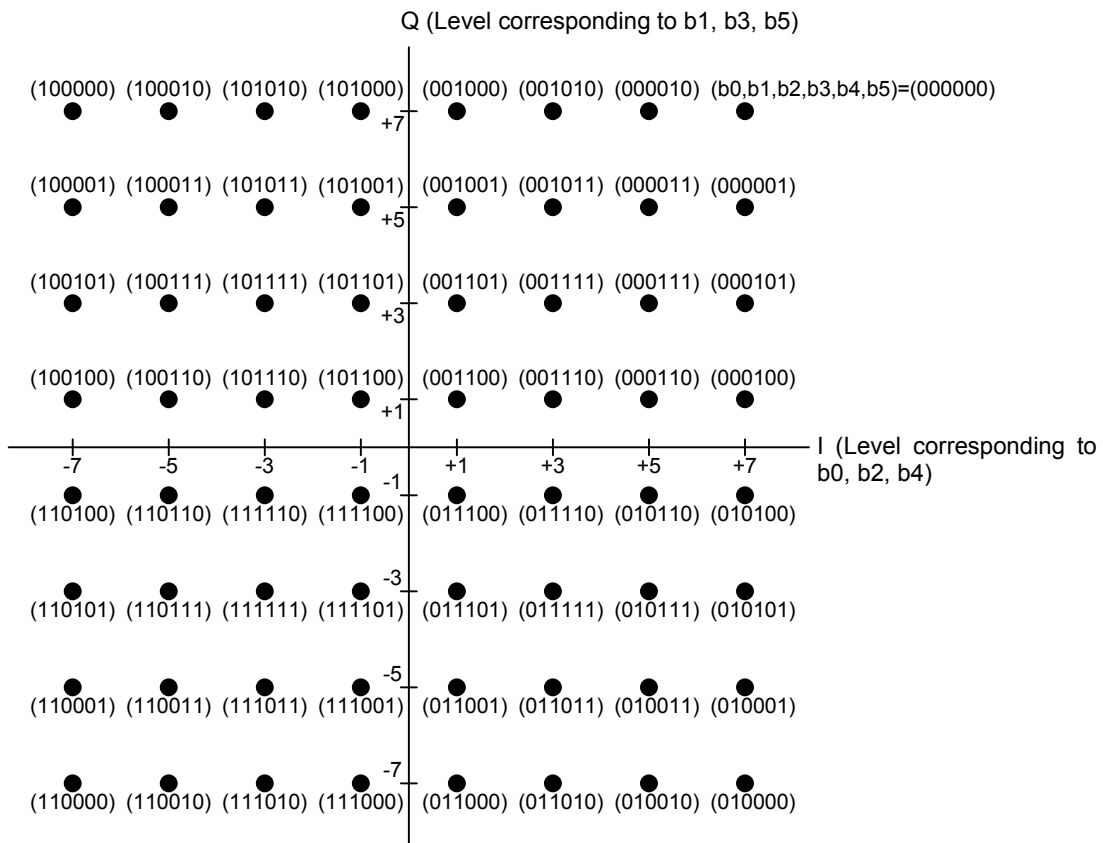

Fig. 3-19: 64QAM Constellation

(Ordinance)

### 3.9.4 Modulation-level normalization

When we let the points in the constellations shown in Figs. 3-13, 3-15, 3-17, and 3-19 be expressed as  $Z (= I + jQ)$ , the transmission-signal level must be normalized by multiplying each of these points by the corresponding normalization factor shown in Table 3-11.

As a result, the average OFDM symbol power becomes 1 regardless of which modulation scheme is used.

Table 3-11: Modulation Level Normalization

Carrier modulation scheme	Normalization factor
$\pi/4$ -shift DQPSK	$Z/\sqrt{2}$
QPSK	$Z/\sqrt{2}$
16QAM	$Z/\sqrt{10}$
64QAM	$Z/\sqrt{42}$

(Ordinance)

### 3.9.5 Data-segment configuration

A data segment is equivalent to data part in an OFDM segment shown in Section 3-12. Data segments consists of 96, 192, and 384 carrier symbols in modes 1, 2, and 3, respectively. Note that  $S_{i,j,k}$  in the figure represents the  $k$ th segment carrier symbol. Note also that “i” must be equivalent to the carrier direction in the OFDM segment, while “j” must be equivalent to the symbol direction in the OFDM segment. Fig. 3-20 shows the data-segment configuration.

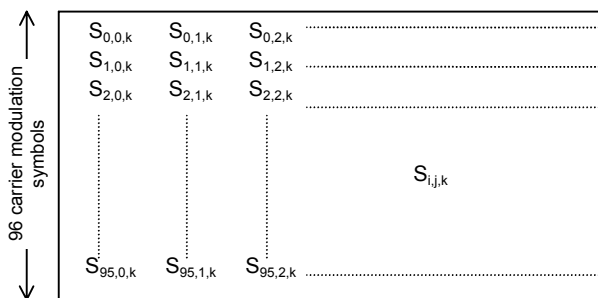

(a) Data-segment configuration in mode 1

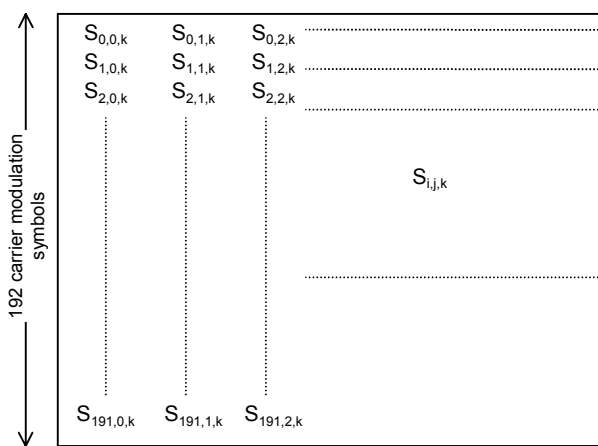

(b) Data-segment configuration in mode 2

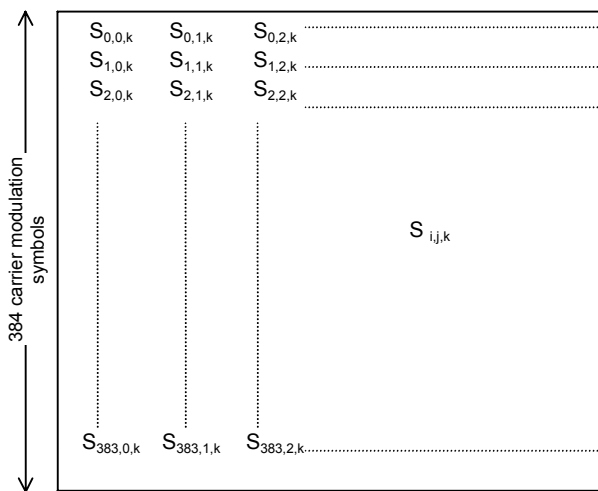

(c) Data-segment configuration in mode 3

Fig. 3-20: Data-Segment Configurations

### 3.10 Combining hierarchical layers

Signals of different hierarchical layers, subjected to channel coding and carrier modulation by the specified parameters, must be combined and inserted into data segments and undergo speed conversion.

Fig. 3-21 shows the configuration of the hierarchical combiner.

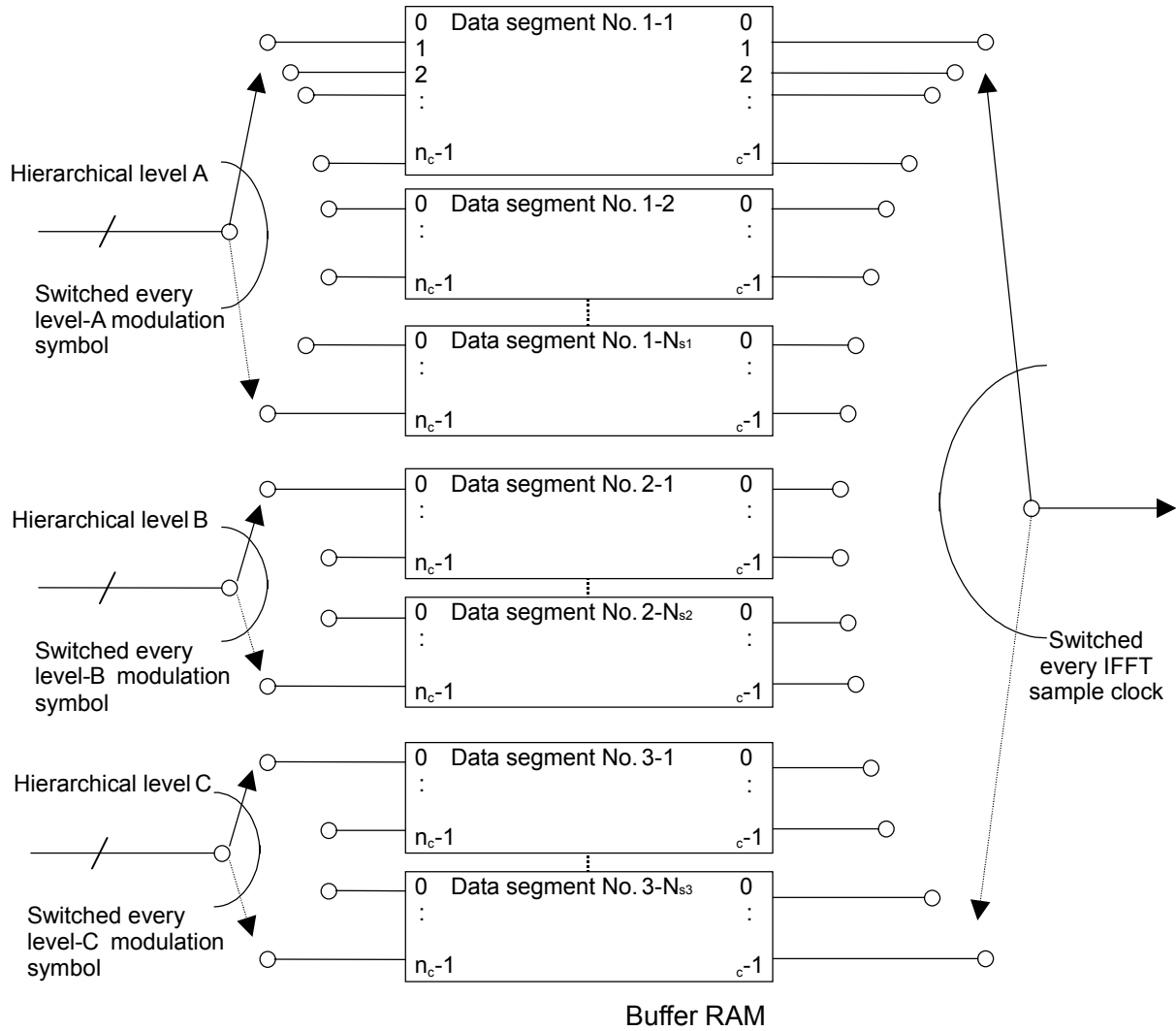

Fig. 3-21: Configuration of the Layer Combiner

In the figure shown above,  $n_c$  is 96, 192, and 384 in modes 1, 2, and 3, respectively. Note also that  $N_{s1} + N_{s2} + N_{s3} = 13$ .

(Ordinance)

### 3.11 Time and frequency interleaving

#### 3.11.1 Time interleaving

Once signals of different hierarchical layers are combined, they must be time-interleaved in units of modulation symbols (for each of the I and Q axes), as shown in Fig. 3-22.

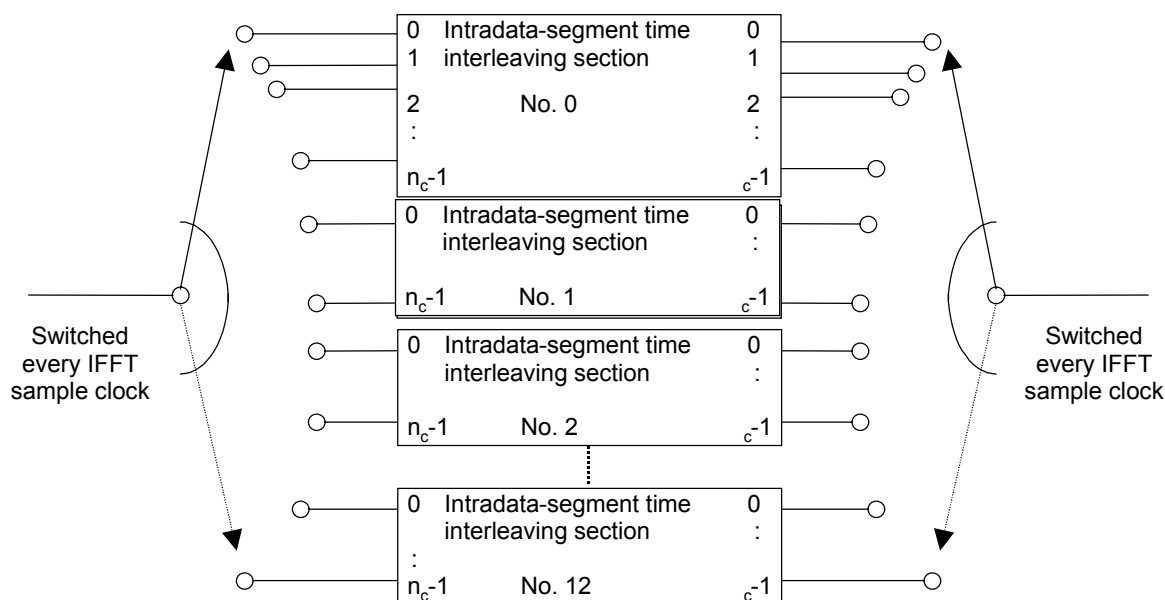

$n_c$  is 96, 192, and 384 in modes 1, 2, and 3, respectively.

Fig. 3-22: Configuration of the Time Interleaving Section

(Notification)

Fig. 3-23 shows the configuration of one of the intra-data segment time interleaving sections presented in Fig. 3-22. Note that “I” in the figure is a parameter related to interleaving length that can be specified for each hierarchical layer. This parameter is shown in Table 3-12.

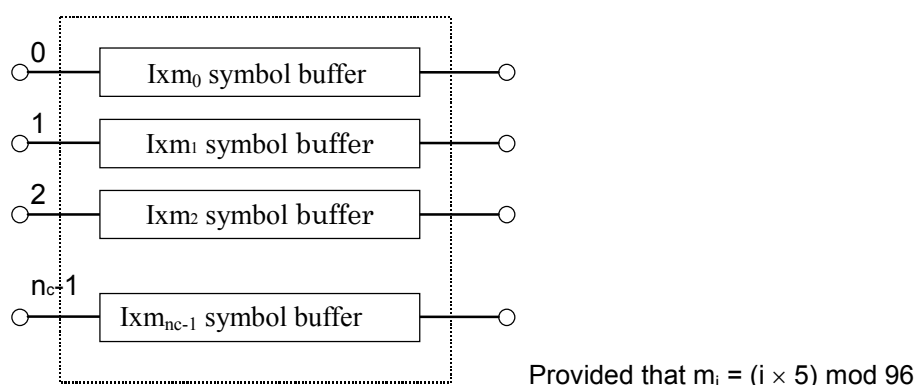

$n_c$  is 96, 192, and 384 in modes 1, 2, and 3, respectively.

Fig. 3-23: Configuration of the Intra-segment Time Interleaving Section

(Notification)

The time interleaving length must be specified as I for each hierarchical layer, independently of other layers. The resulting difference in delay time must be corrected on the transmitting side

using the number of symbols or the delay appropriate for each layer shown in Table 3-12, such that the total number of transmission and reception delays is a multiple of the number of frames.

Table 3-12: Time Interleaving Lengths and Delay Adjustment Values

Mode 1			Mode 2			Mode 3		
Length (l)	Number of delay-adjustment symbols	Number of delayed frames in transmission and reception	Length (l)	Number of delay-adjustment symbols	Number of delayed frames in transmission and reception	Length (l)	Number of delay-adjustment symbols	Number of delayed frames in transmission and reception
0	0	0	0	0	0	0	0	0
4	28	2	2	14	1	1	109	1
8	56	4	4	28	2	2	14	1
16	112	8	8	56	4	4	28	2

(Notification)

Note that this delay adjustment must be conducted on signals prior to time interleaving.

[Description]

Time interleaving is intended to ensure improved the robustness against fading interference by randomizing symbol data in terms of the time after modulation. Specification of the interleaving length for each hierarchical layer allows the optimal interleaving length to be specified for the target channel if each layer employs a different channel, that is, a type of reception that differs from that of other layers.

Fig. 3-24 shows the arrangement of carriers following time interleaving.

The purpose of using convolutional interleaving as the time interleaving method is to reduce the total transmission and reception delay time and decrease the amount of receiver memory taken up.

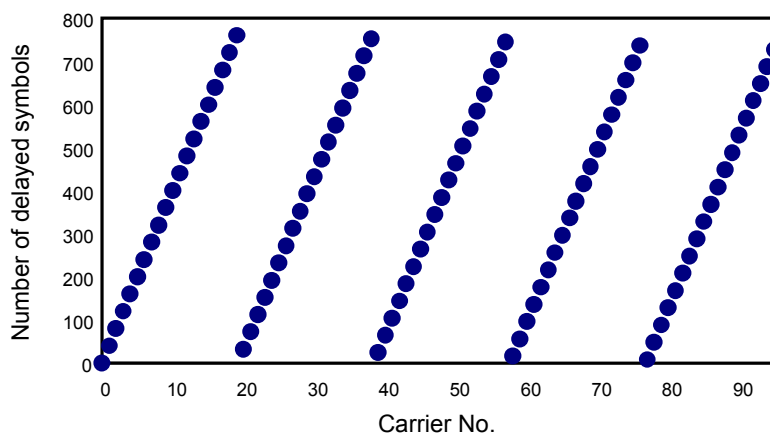

Fig. 3-24: Arrangement of Carriers Following Time Interleaving (Mode 1, l=8)

### 3.11.2 Frequency interleaving

Fig. 3-25 shows the configuration of the frequency interleaving section.

During segment division, data-segment numbers 0 to 12 are assigned sequentially to the partial-reception portion, differential modulations (segments for which DQPSK is specified for modulating carriers), and coherent modulation (segments for which QPSK, 16QAM, or 64QAM is specified for modulating carriers).

As for the relationship between the hierarchical configuration and data segments, data segments of the same hierarchical level must be successively arranged, and hierarchical layers must be named layer A, B, and C sequentially, in ascending order of data-segment number (that is, from smaller to larger segment numbers).

Inter-segment interleaving must be conducted on two or more data segments when they belong to the same type of modulated portion, even if their hierarchical levels differ.

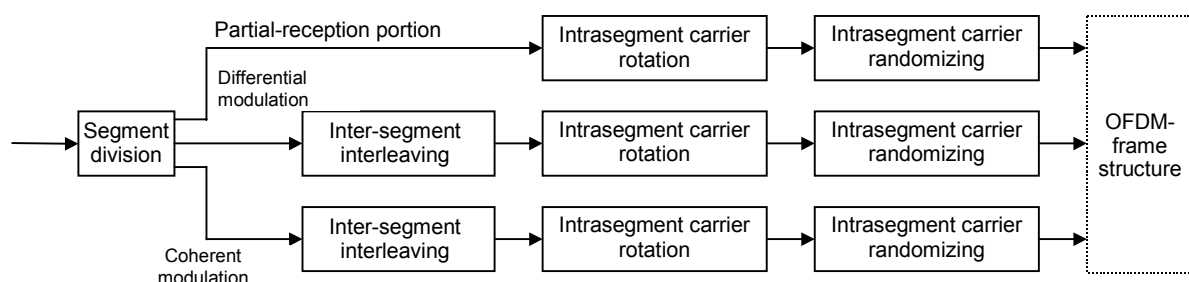

Fig. 3-25: Configuration of the Frequency Interleaving Section

(Notification)

[Description]

Inter-segment interleaving is not conducted on the partial-reception portion, as it is assumed that the receiver designed to receive only that segment will be used.

Note also that because the differential and synchronous modulations differ in terms of frame structure, as shown in Section 3-12 (“Frame structure”), inter-segment interleaving is performed in each group.

Inter-segment interleaving conducted across layer boundaries is intended to maximize the frequency interleaving effect.

### 3.11.2.1 Inter-segment interleaving

Inter-segment interleaving must be conducted on each of the differential modulation (DQPSK) and synchronous modulation (QPSK, 16QAM, 64QAM), as shown in Figs. 3-26 (a), 3-26 (b), and 3-26 (c). Note that  $S_{i,j,k}$ , and  $n$  in the figures represent carrier symbols in the data-segment configuration (Fig. 3-20) and the number of segments assigned to the differential and synchronous modulation, respectively.

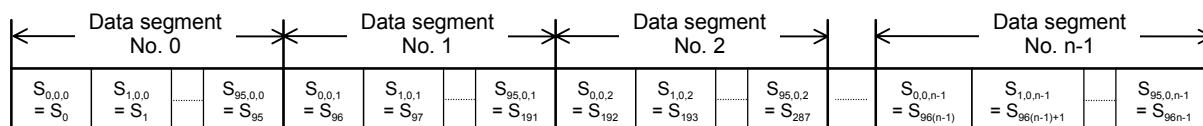

Arrangement of symbols before interleaving

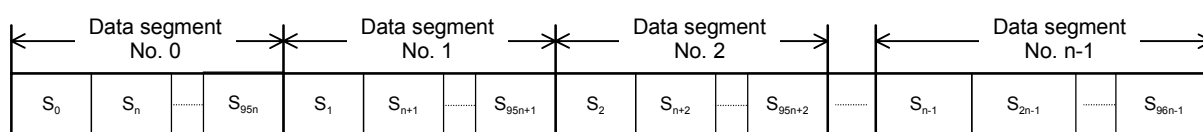

Arrangement of symbols after interleaving

Fig. 3-26 (a): Inter-segment Interleaving in Mode 1

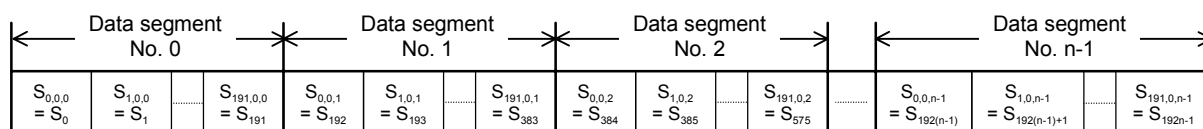

Arrangement of symbols before interleaving

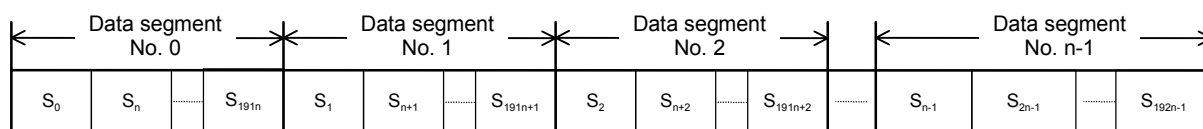

Arrangement of symbols after interleaving

Fig. 3-26 (b): Inter-segment Interleaving in Mode 2

(Notification)

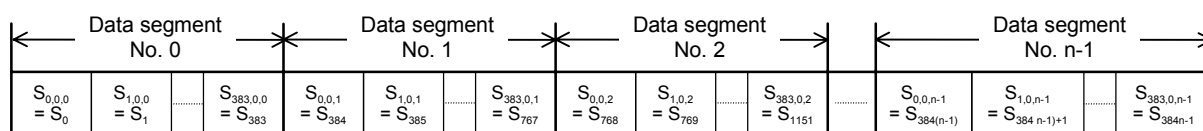

Arrangement of symbols before interleaving

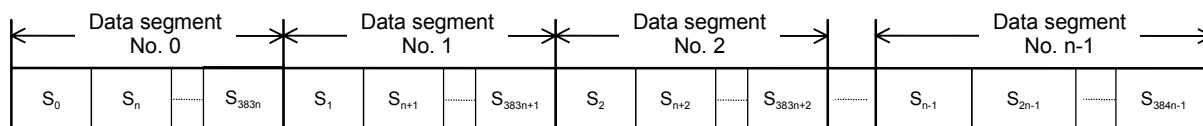

Arrangement of symbols after interleaving

Fig. 3-26 (c): Inter-segment Interleaving in Mode 3

(Notification)

### 3.11.2.2 Intra-segment interleaving

Intra-segment interleaving must be conducted in two steps: carrier rotation by segment number, followed by carrier randomizing.

In the carrier rotation, carrier changes are carried out as shown in Figs. 3-27 (a), 3-27 (b), and 3-27 (c). Here,  $S'_{i,j,k}$  represents the carrier symbol of the  $k$ th segment following inter-segment interleaving.

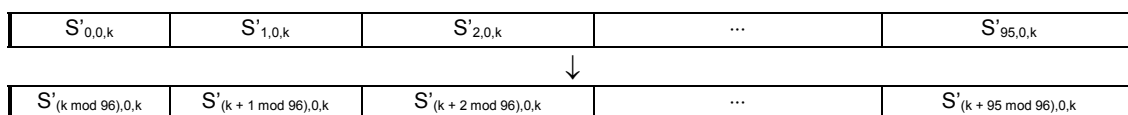

Fig. 3-27 (a): Carrier Rotation in Mode 1

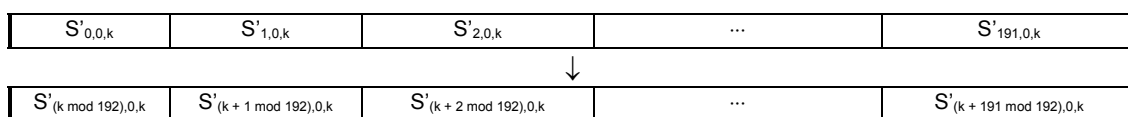

Fig. 3-27 (b): Carrier Rotation in Mode 2

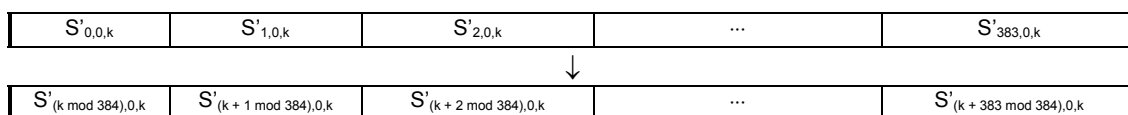

Fig. 3-27 (c): Carrier Rotation in Mode 3

(Notification)

**ARIB STD – B31**  
**Version 1.6-E2**

Next, carrier randomizing in Mode 1, 2, and 3 is shown in Table 3-13 (a), (b), and (c), respectively.

These tables show which carriers are assigned, as a result of carrier randomizing, to carrier-rotated data arranged in ascending order of carrier number.

**Table 3-13 (a): Intra-segment Carrier Randomizing in Mode 1**

Before	0	1	2	3	4	5	6	7	8	9	10	11	12	13	14	15	16	17	18	19	20	21	22	23
After	80	93	63	92	94	55	17	81	6	51	9	85	89	65	52	15	73	66	46	71	12	70	18	13

Before	24	25	26	27	28	29	30	31	32	33	34	35	36	37	38	39	40	41	42	43	44	45	46	47
After	95	34	1	38	78	59	91	64	0	28	11	4	45	35	16	7	48	22	23	77	56	19	8	36

Before	48	49	50	51	52	53	54	55	56	57	58	59	60	61	62	63	64	65	66	67	68	69	70	71
After	39	61	21	3	26	69	67	20	74	86	72	25	31	5	49	42	54	87	43	60	29	2	76	84

Before	74	73	74	75	76	77	78	79	80	81	82	83	84	85	86	87	88	89	90	91	92	93	94	95
After	83	40	14	79	27	57	44	37	30	68	47	88	75	41	90	10	33	32	62	50	58	82	53	24

**Table 3-13 (b): Intra-segment Carrier Randomizing in Mode 2**

Before	0	1	2	3	4	5	6	7	8	9	10	11	12	13	14	15	16	17	18	19	20	21	22	23
After	98	35	67	116	135	17	5	93	73	168	54	143	43	74	165	48	37	69	154	150	107	76	176	79

Before	24	25	26	27	28	29	30	31	32	33	34	35	36	37	38	39	40	41	42	43	44	45	46	47
After	175	36	28	78	47	128	94	163	184	72	142	2	86	14	130	151	114	68	46	183	122	112	180	42

Before	48	49	50	51	52	53	54	55	56	57	58	59	60	61	62	63	64	65	66	67	68	69	70	71
After	105	97	33	134	177	84	170	45	187	38	167	10	189	51	117	156	161	25	89	125	139	24	19	57

Before	72	73	74	75	76	77	78	79	80	81	82	83	84	85	86	87	88	89	90	91	92	93	94	95
After	71	39	77	191	88	85	0	162	181	113	140	61	75	82	101	174	118	20	136	3	121	190	120	92

Before	96	97	98	99	100	101	102	103	104	105	106	107	108	109	110	111	112	113	114	115	116	117	118	119
After	160	52	153	127	65	60	133	147	131	87	22	58	100	111	141	83	49	132	12	155	146	102	164	66

Before	120	121	122	123	124	125	126	127	128	129	130	131	132	133	134	135	136	137	138	139	140	141	142	143
After	1	62	178	15	182	96	80	119	23	6	166	56	99	123	138	137	21	145	185	18	70	129	95	90

Before	144	145	146	147	148	149	150	151	152	153	154	155	156	157	158	159	160	161	162	163	164	165	166	167
After	149	109	124	50	11	152	4	31	172	40	13	32	55	159	41	8	7	144	16	26	173	81	44	103

Before	168	169	170	171	172	173	174	175	176	177	178	179	180	181	182	183	184	185	186	187	188	189	190	191
After	64	9	30	157	126	179	148	63	188	171	106	104	158	115	34	186	29	108	53	91	169	110	27	59

(Notification)

Table 3-13 (c): Intra-segment Carrier Randomizing in Mode 3

Before	0	1	2	3	4	5	6	7	8	9	10	11	12	13	14	15	16	17	18	19	20	21	22	23
After	62	13	371	11	285	336	365	220	226	92	56	46	120	175	298	352	172	235	53	164	368	187	125	82

Before	24	25	26	27	28	29	30	31	32	33	34	35	36	37	38	39	40	41	42	43	44	45	46	47
After	5	45	173	258	135	182	141	273	126	264	286	88	233	61	249	367	310	179	155	57	123	208	14	227

Before	48	49	50	51	52	53	54	55	56	57	58	59	60	61	62	63	64	65	66	67	68	69	70	71
After	100	311	205	79	184	185	328	77	115	277	112	20	199	178	143	152	215	204	139	234	358	192	309	183

Before	72	73	74	75	76	77	78	79	80	81	82	83	84	85	86	87	88	89	90	91	92	93	94	95
After	81	129	256	314	101	43	97	324	142	157	90	214	102	29	303	363	261	31	22	52	305	301	293	177

Before	96	97	98	99	100	101	102	103	104	105	106	107	108	109	110	111	112	113	114	115	116	117	118	119
After	116	296	85	196	191	114	58	198	16	167	145	119	245	113	295	193	232	17	108	283	246	64	237	189

Before	120	121	122	123	124	125	126	127	128	129	130	131	132	133	134	135	136	137	138	139	140	141	142	143
After	128	373	302	320	239	335	356	39	347	351	73	158	276	243	99	38	287	3	330	153	315	117	289	213

Before	144	145	146	147	148	149	150	151	152	153	154	155	156	157	158	159	160	161	162	163	164	165	166	167
After	210	149	383	337	339	151	241	321	217	30	334	161	322	49	176	359	12	346	60	28	229	265	288	225

Before	168	169	170	171	172	173	174	175	176	177	178	179	180	181	182	183	184	185	186	187	188	189	190	191
After	382	59	181	170	319	341	86	251	133	344	361	109	44	369	268	257	323	55	317	381	121	360	260	275

Before	192	193	194	195	196	197	198	199	200	201	202	203	204	205	206	207	208	209	210	211	212	213	214	215
After	190	19	63	18	248	9	240	211	150	230	332	231	71	255	350	355	83	87	154	218	138	269	348	130

Before	216	217	218	219	220	221	222	223	224	225	226	227	228	229	230	231	232	233	234	235	236	237	238	239
After	160	278	377	216	236	308	223	254	25	98	300	201	137	219	36	325	124	66	353	169	21	35	107	50

Before	240	241	242	243	244	245	246	247	248	249	250	251	252	253	254	255	256	257	258	259	260	261	262	263
After	106	333	326	262	252	271	263	372	136	0	366	206	159	122	188	6	284	96	26	200	197	186	345	340

Before	264	265	266	267	268	269	270	271	272	273	274	275	276	277	278	279	280	281	282	283	284	285	286	287
After	349	103	84	228	212	2	67	318	1	74	342	166	194	33	68	267	111	118	140	195	105	202	291	259

Before	288	289	290	291	292	293	294	295	296	297	298	299	300	301	302	303	304	305	306	307	308	309	310	311
After	23	171	65	281	24	165	8	94	222	331	34	238	364	376	266	89	80	253	163	280	247	4	362	379

Before	312	313	314	315	316	317	318	319	320	321	322	323	324	325	326	327	328	329	330	331	332	333	334	335
After	290	279	54	78	180	72	316	282	131	207	343	370	306	221	132	7	148	299	168	224	48	47	357	313

Before	336	337	338	339	340	341	342	343	344	345	346	347	348	349	350	351	352	353	354	355	356	357	358	359
After	75	104	70	147	40	110	374	69	146	37	375	354	174	41	32	304	307	312	15	272	134	242	203	209

Before	360	361	362	363	364	365	366	367	368	369	370	371	372	373	374	375	376	377	378	379	380	381	382	383
After	380	162	297	327	10	93	42	250	156	338	292	144	378	294	329	127	270	76	95	91	244	274	27	51

(Notification)

[Description]

Carrier rotation and carrier randomizing are intended to eliminate periodicity in carrier arrangement. These operations make it possible to prevent burst errors of a specific segment's carrier, which may occur if the carrier arrangement period matches the frequency-selective fading after inter-segment interleaving.

Fig. 3-28 (a) and (b) show examples of carrier randomizing in mode 1 and carrier randomizing including time interleaving, respectively.

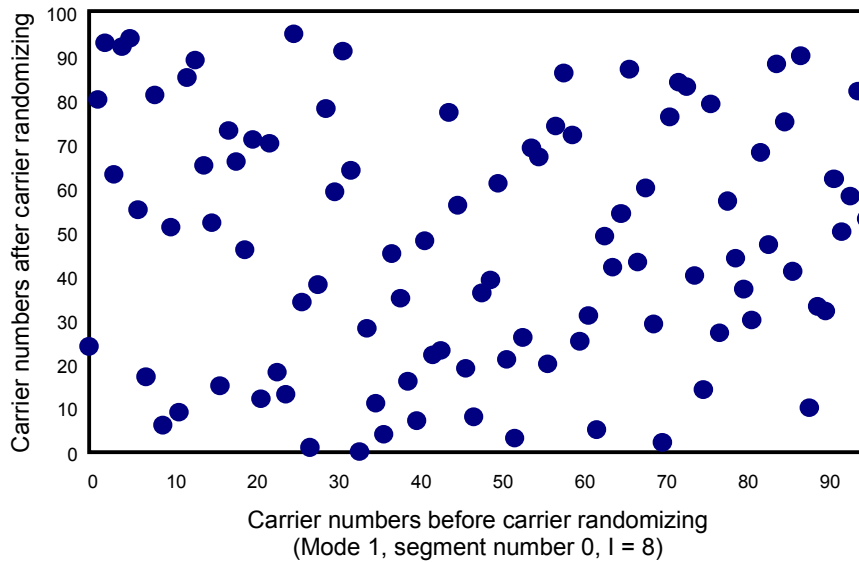

Fig. 3-28 (a): Example of Carrier Arrangement before and after Carrier Randomizing

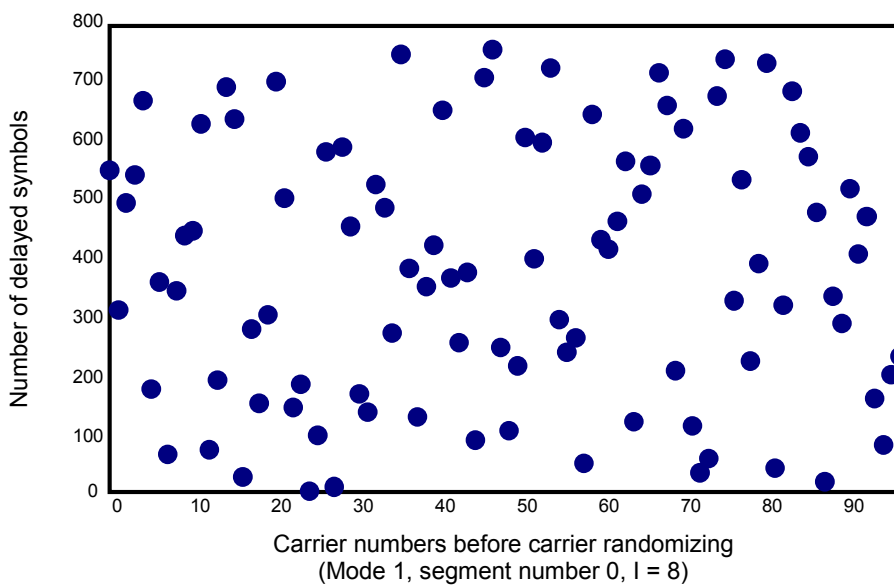

Fig. 3-28 (b): Example of Carrier Arrangement after Time Interleaving and Carrier Randomizing

### 3.12 Frame structure

All data-processing tasks in data segments required for channel coding are complete when the steps discussed up to Section 3.11 are performed. This section stipulates OFDM-frame structure achieved through the addition of various pilot signals to data segments.

#### 3.12.1 OFDM-segment configuration for the differential modulation

Fig. 3-29 shows the OFDM-segment configuration for a differential modulation (DQPSK) (Mode 1).

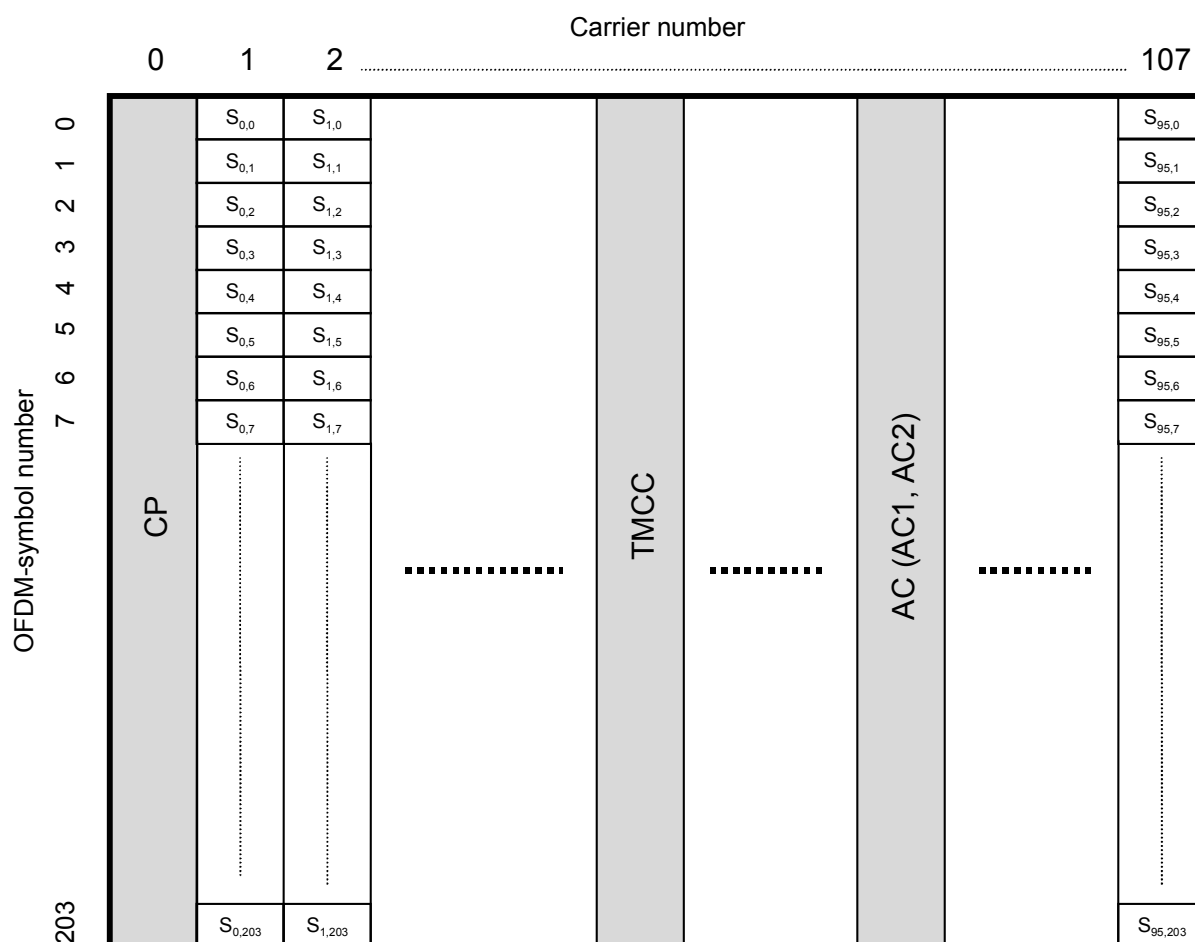

Fig. 3-29: OFDM-Segment Configuration for the Differential Modulation

(Ordinance)

Note, however, that  $S_{i,j}$  represents carrier symbols within data segments following interleaving. Note also that the CP (Continual Pilot), the TMCC (Transmission and Multiplexing Configuration Control), and the AC (Auxiliary Channel) are the continual carrier, the signal for conveying control information, and the extension signal for conveying additional information, respectively. In Mode 1, carrier numbers 0 to 107 are available, while in modes 2 and 3, carrier numbers 0 to 215 and 0 to 431 are assigned, respectively.

The arrangement of various control signals (represented by carrier numbers) that are added by the OFDM-frame structure section in each mode is shown in Tables 3-14 (a), (b), and (c).

**Table 3-14: Arrangement of the CP, TMCC, and AC Carriers for the Differential Modulation**  
**(a) Arrangement of the CP, AC, and TMCC Carriers in Mode 1**

Segment No.	11	9	7	5	3	1	0	2	4	6	8	10	12
CP	0	0	0	0	0	0	0	0	0	0	0	0	0
AC1_1	10	53	61	11	20	74	35	76	4	40	8	7	98
AC1_2	28	83	100	101	40	100	79	97	89	89	64	89	101
AC2_1	3	3	29	28	23	30	3	5	13	72	36	25	10
AC2_2	45	15	41	45	63	81	72	18	93	95	48	30	30
AC2_3	59	40	84	81	85	92	85	57	98	100	52	42	55
AC2_4	77	58	93	91	105	103	89	92	102	105	74	104	81
TMCC 1	13	25	4	36	10	7	49	31	16	5	78	34	23
TMCC 2	50	63	7	48	28	25	61	39	30	10	82	48	37
TMCC 3	70	73	17	55	44	47	96	47	37	21	85	54	51
TMCC 4	83	80	51	59	47	60	99	65	74	44	98	70	68
TMCC 5	87	93	71	86	54	87	104	72	83	61	102	101	105

Segment numbers are arranged in ascending order of frequency along the frequency axis (see Section 3.14).

(Notification)

(b) Arrangement of the CP, AC, and TMCC Carriers in Mode 2

Segment No.	11	9	7	5	3	1	0	2	4	6	8	10	12
CP	0	0	0	0	0	0	0	0	0	0	0	0	0
AC1_1	10	61	20	35	4	8	98	53	11	74	76	40	7
AC1_2	28	100	40	79	89	64	101	83	101	100	97	89	89
AC1_3	161	119	182	184	148	115	118	169	128	143	112	116	206
AC1_4	191	209	208	205	197	197	136	208	148	187	197	172	209
AC2_1	3	29	23	3	13	36	10	3	28	30	5	72	25
AC2_2	45	41	63	72	93	48	30	15	45	81	18	95	30
AC2_3	59	84	85	85	98	52	55	40	81	92	57	100	42
AC2_4	77	93	105	89	102	74	81	58	91	103	92	105	104
AC2_5	108	108	108	108	108	108	108	108	108	108	108	108	108
AC2_6	111	136	138	113	180	133	111	137	131	111	121	144	118
AC2_7	123	153	189	126	203	138	153	149	171	180	201	156	138
AC2_8	148	189	200	165	208	150	167	192	193	193	206	160	163
AC2_9	166	199	211	200	213	212	185	201	213	197	210	182	189
TMCC 1	13	4	10	49	16	78	23	25	36	7	31	5	34
TMCC 2	50	7	28	61	30	82	37	63	48	25	39	10	48
TMCC 3	70	17	44	96	37	85	51	73	55	47	47	21	54
TMCC 4	83	51	47	99	74	98	68	80	59	60	65	44	70
TMCC 5	87	71	54	104	83	102	105	93	86	87	72	61	101
TMCC 6	133	144	115	139	113	142	121	112	118	157	124	186	131
TMCC 7	171	156	133	147	118	156	158	115	136	169	138	190	145
TMCC 8	181	163	155	155	129	162	178	125	152	204	145	193	159
TMCC 9	188	167	168	173	152	178	191	159	155	207	182	206	176
TMCC 10	201	194	195	180	169	209	195	179	162	212	191	210	213

(Notification)

(c) Arrangement of the CP, AC, and TMCC Carriers in Mode 3

Segment No.	11	9	7	5	3	1	0	2	4	6	8	10	12
CP	0	0	0	0	0	0	0	0	0	0	0	0	0
AC1_1	10	20	4	98	11	76	7	61	35	8	53	74	40
AC1_2	28	40	89	101	101	97	89	100	79	64	83	100	89
AC1_3	161	182	148	118	128	112	206	119	184	115	169	143	116
AC1_4	191	208	197	136	148	197	209	209	205	197	208	187	172
AC1_5	277	251	224	269	290	256	226	236	220	314	227	292	223
AC1_6	316	295	280	299	316	305	244	256	305	317	317	313	305
AC1_7	335	400	331	385	359	332	377	398	364	334	344	328	422
AC1_8	425	421	413	424	403	388	407	424	413	352	364	413	425
AC2_1	3	23	13	10	28	5	25	29	3	36	3	30	72
AC2_2	45	63	93	30	45	18	30	41	72	48	15	81	95
AC2_3	59	85	98	55	81	57	42	84	85	52	40	92	100
AC2_4	77	105	102	81	91	92	104	93	89	74	58	103	105
AC2_5	108	108	108	108	108	108	108	108	108	108	108	108	108
AC2_6	111	138	180	111	131	121	118	136	113	133	137	111	144
AC2_7	123	189	203	153	171	201	138	153	126	138	149	180	156
AC2_8	148	200	208	167	193	206	163	189	165	150	192	193	160
AC2_9	166	211	213	185	213	210	189	199	200	212	201	197	182
AC2_10	216	216	216	216	216	216	216	216	216	216	216	216	216
AC2_11	245	219	252	219	246	288	219	239	229	226	244	221	241
AC2_12	257	288	264	231	297	311	261	279	309	246	261	234	246
AC2_13	300	301	268	256	308	316	275	301	314	271	297	273	258
AC2_14	309	305	290	274	319	321	293	321	318	297	307	308	320
AC2_15	324	324	324	324	324	324	324	324	324	324	324	324	324
AC2_16	352	329	349	353	327	360	327	354	396	327	347	337	334
AC2_17	369	342	354	365	396	372	339	405	419	369	387	417	354
AC2_18	405	381	366	408	409	376	364	416	424	383	409	422	379
AC2_19	415	416	428	417	413	398	382	427	429	401	429	426	405
TMCC 1	13	10	16	23	36	31	34	4	49	78	25	7	5
TMCC 2	50	28	30	37	48	39	48	7	61	82	63	25	10
TMCC 3	70	44	37	51	55	47	54	17	96	85	73	47	21
TMCC 4	83	47	74	68	59	65	70	51	99	98	80	60	44
TMCC 5	87	54	83	105	86	72	101	71	104	102	93	87	61
TMCC 6	133	115	113	121	118	124	131	144	139	142	112	157	186
TMCC 7	171	133	118	158	136	138	145	156	147	156	115	169	190
TMCC 8	181	155	129	178	152	145	159	163	155	162	125	204	193
TMCC 9	188	168	152	191	155	182	176	167	173	178	159	207	206
TMCC 10	201	195	169	195	162	191	213	194	180	209	179	212	210
TMCC 11	220	265	294	241	223	221	229	226	232	239	252	247	250
TMCC 12	223	277	298	279	241	226	266	244	246	253	264	255	264
TMCC 13	233	312	301	289	263	237	286	260	253	267	271	263	270
TMCC 14	267	315	314	296	276	260	299	263	290	284	275	281	286
TMCC 15	287	320	318	309	303	277	303	270	299	321	302	288	317
TMCC 16	360	355	358	328	373	402	349	331	329	337	334	340	347
TMCC 17	372	363	372	331	385	406	387	349	334	374	352	354	361
TMCC 18	379	371	378	341	420	409	397	371	345	394	368	361	375
TMCC 19	383	389	394	375	423	422	404	384	368	407	371	398	392
TMCC 20	410	396	425	395	428	426	417	411	385	411	378	407	429

(Notification)

The CP of a differential modulation’s segment serves as the SP of a synchronous modulation’s segment when the differential modulation’s segment at the lowermost frequency is adjacent to one of the synchronous modulation’s segments. The CP is thus provided at this low-frequency end. The receiver synchronously detects this CP as the high-frequency end the SP of the synchronous modulation’s segment.

The TMCC and AC (AC1, AC2) carriers are arranged randomly with respect to the frequency in order to reduce the degradation caused by periodic dips on channel characteristics under multi-path environment. AC carriers not only serve as AC pilot signal, but can also be used as carriers for additional information on transmission control.

Note that AC1 carriers for the differential modulation’s segments are arranged at the same positions as those for the synchronous modulation’s segments.

### 3.12.2 OFDM-segment configuration for the synchronous modulation

Fig. 3-30 shows an example of OFDM-segment configuration for a synchronous modulation (QPSK, 16QAM, 64QAM) in mode 1.  $S_{i,j}$  represents carrier symbols within data segments following interleaving.

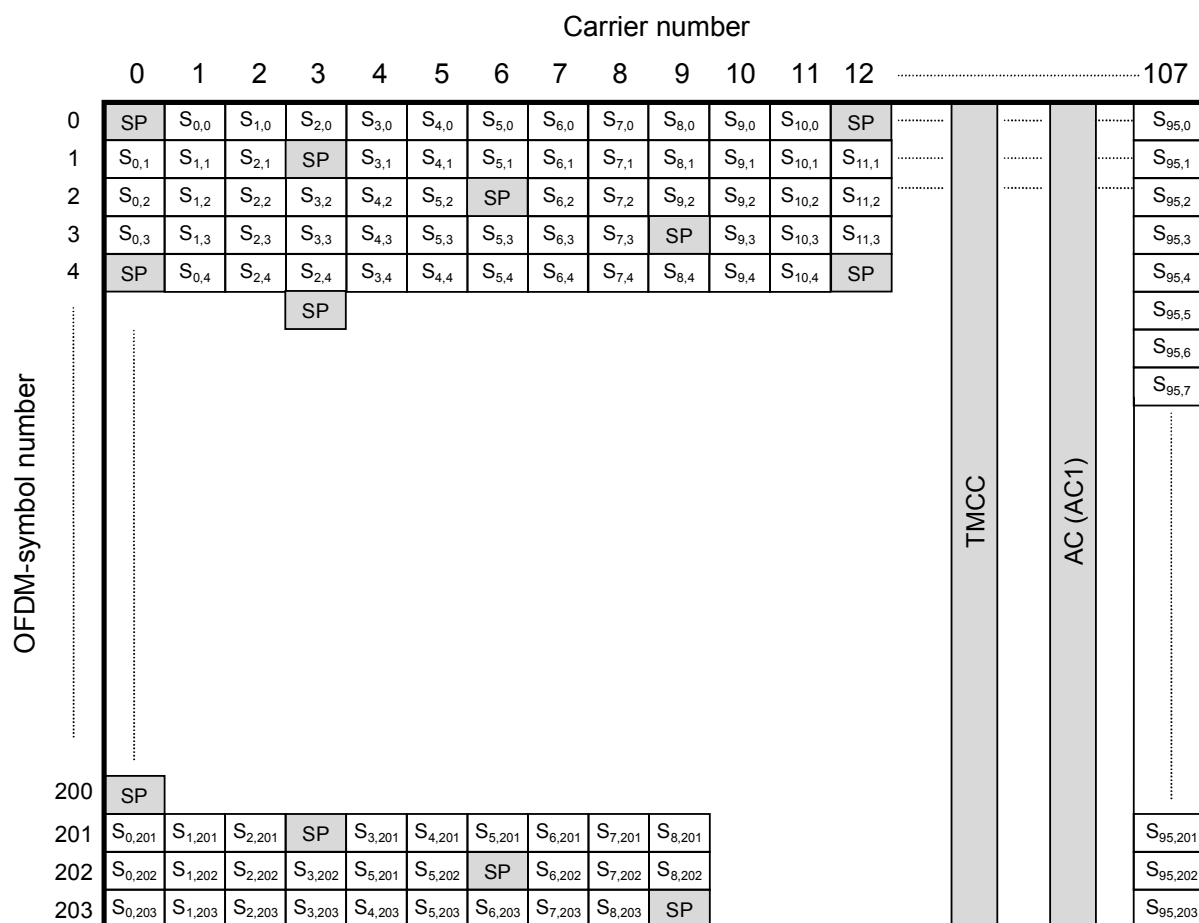

Fig. 3-30: OFDM-Segment Configuration for the Synchronous Modulation

(Ordinance)

The SP (Scattered Pilot) is inserted into a segment once every 12 carriers in the carrier direction, and once every 4 symbols in the symbol direction, as shown in the figure. Table 3-15 shows the AC and TMCC carrier arrangements.

The AC1 carrier arrangement for the synchronous modulation is the same as that for the differential modulation. Note that AC2 is available only for the differential modulation. Therefore, the synchronous modulation does not have any AC2.

**Table 3-15: AC and TMCC Carrier Arrangements for the Synchronous modulation**

**(a) AC and TMCC Carrier Arrangements in Mode 1**

Segment No.	11	9	7	5	3	1	0	2	4	6	8	10	12
AC1_1	10	53	61	11	20	74	35	76	4	40	8	7	98
AC1_2	28	83	100	101	40	100	79	97	89	89	64	89	101
TMCC 1	70	25	17	86	44	47	49	31	83	61	85	101	23

**(b) AC and TMCC Carrier Arrangements in Mode 2**

Segment No.	11	9	7	5	3	1	0	2	4	6	8	10	12
AC1_1	10	61	20	35	4	8	98	53	11	74	76	40	7
AC1_2	28	100	40	79	89	64	101	83	101	100	97	89	89
AC1_3	161	119	182	184	148	115	118	169	128	143	112	116	206
AC1_4	191	209	208	205	197	197	136	208	148	187	197	172	209
TMCC 1	70	17	44	49	83	85	23	25	86	47	31	61	101
TMCC 2	133	194	155	139	169	209	178	125	152	157	191	193	131

**(c) AC and TMCC Carrier Arrangements in Mode 3**

Segment No.	11	9	7	5	3	1	0	2	4	6	8	10	12
AC1_1	10	20	4	98	11	76	7	61	35	8	53	74	40
AC1_2	28	40	89	101	101	97	89	100	79	64	83	100	89
AC1_3	161	182	148	118	128	112	206	119	184	115	169	143	116
AC1_4	191	208	197	136	148	197	209	209	205	197	208	187	172
AC1_5	277	251	224	269	290	256	226	236	220	314	227	292	223
AC1_6	316	295	280	299	316	305	244	256	305	317	317	313	305
AC1_7	335	400	331	385	359	332	377	398	364	334	344	328	422
AC1_8	425	421	413	424	403	388	407	424	413	352	364	413	425
TMCC 1	70	44	83	23	86	31	101	17	49	85	25	47	61
TMCC 2	133	155	169	178	152	191	131	194	139	209	125	157	193
TMCC 3	233	265	301	241	263	277	286	260	299	239	302	247	317
TMCC 4	410	355	425	341	373	409	349	371	385	394	368	407	347

(Notification)

The TMCC and AC (AC1) carriers are arranged randomly with respect to the frequency direction in order to reduce the periodic impact of dip on channel characteristics caused by multipath. Note that AC1 carriers for the differential modulation's segments are arranged at the same positions as those for the synchronous modulation's segments.



Table 3-17:  $W_i$  and Modulating Signal

$W_i$ value	Modulating-signal amplitude (I, Q)
1	(-4/3, 0)
0	(+4/3, 0)

(Ordinance)

### 3.13.2 Continual pilot (CP)

As with the scattered pilot discussed in Section 3.13.1, CP is a BPSK signal modulated in accordance with the carrier position (carrier number within a segment) into which it is to be inserted, and also in accordance with the  $W_i$  value. The correspondence between  $W_i$  and the modulating signal is the same as that shown in Table 3-17. Note that the phase angle of CP determined with respect to carrier position is constant in every symbol.

### 3.13.3 TMCC

TMCC is transmitted by means of the DBPSK signal modulated in accordance with the information shown in Section 3.14. The reference for differential modulation  $B_0$  is stipulated by  $W_i$  shown in Section 3.13. After differential coding, the TMCC modulating signal takes signal points (+4/3, 0) and (-4/3, 0) for information 0 and 1, respectively.

Information  $B'_0$  to  $B'_{203}$  available following differential coding is stipulated in relation to information  $B_0$  to  $B_{203}$  prior to differential coding, as follows:

$$B'_0 = W_i \text{ (reference for differential modulation)}$$

$$B'_k = B'_{k-1} \oplus B_k \text{ (} k = 1, 203, \oplus \text{ represents EXCLUSIVE OR)}$$

### 3.13.4 AC (Auxiliary Channel)

AC is a channel designed to convey additional information on modulating signal-transmission control.

AC's additional information is transmitted by modulating the pilot carrier of a type similar to CP through DBPSK. The reference for differential modulation is provided at the first frame symbol, and takes the signal point that corresponds to the  $W_i$  value stipulated in Section 3.13.1.

The AC modulating signal takes signal points (+4/3, 0) and (-4/3, 0) for information 0 and 1, respectively, available following differential coding. If there is no additional information, information 1 is inserted as stuffing bits.

Two channels are available as ACs: AC1 channel with which the same carrier position is employed for all segments, regardless of which modulation scheme is used; and AC2 channel, which is provided in the differential modulation's segments.

To ensure diversity in applications, we include only one stipulation in relation to the AC transmission scheme, which is that DBPSK is used as the modulation scheme.

Table 3-18 shows examples of the transmission capacity per segment. Note that the transmission capacity for all television channels varies depending on the segment configuration.

Table 3-18: Examples of Transmission Capacities for AC Carriers (Mode 1, Guard Ratio of 1/8)

Type	Synchronous modulation's segment		Differential modulation's segment	
	1	13	1	13
AC1	7.0 (kbps)	91.3 (kbps)	7.0 (kbps)	91.3 (kbps)
AC2	—	—	14.0 (kbps)	182.5 (kbps)

(without error-correction coding)

### 3.14 Transmission spectrum configuration

Fig. 3-32 stipulates the arrangement of OFDM segments. Segment No. 0 must be positioned at the center of the entire band, with successively numbered segments placed alternately above and below that segment.

For hierarchical transmission, segments of the differential modulation must be assigned alternately above and below segment No. 0, in ascending order of segment number, with segments of the synchronous modulation assigned alternately above and below segments of the differential modulation.

(“Partial-reception portion,” “Differential modulation portion,” and “Synchronous modulation portion” in the figure are merely examples of segment usage.)

Note also that, for hierarchical transmission, the segment position assigned to partial reception must be always No. 0.

To make up the entire transmission spectrum, a continuous carrier with its phase stipulated by  $W_i$  is provided at the right-hand end of the band. The modulating signal used for the rightmost carrier is shown in Table 3-19.



Fig. 3-32: OFDM-Segment Numbers on the Transmission Spectrum and Example of Usage

(Ordinance)

Table 3-19: Modulating Signal for the Rightmost Continuous Carrier

Mode	Modulating-signal amplitude (I, Q)
Mode 1	(-4/3, 0)
Mode 2	(+4/3, 0)
Mode 3	(+4/3, 0)

(Ordinance)

The continuous carrier at the uppermost frequency of the television band is a pilot carrier required for demodulation when the adjacent segment is a synchronous modulation. This carrier is always provided with ISDB-T.

The partial-reception segment must be assigned to No. 0 in order to ensure easy tuning by the receiver.

### 3.14.1 RF-signal format

The signal format in the RF band is stipulated as follows:

#### Definition

- $k$ : Carrier number that is successive across the entire band, with number 0 assigned to carrier 0 of segment 11
- $n$ : Symbol number
- $K$ : Carrier total count (mode 1: 1405; mode 2: 2809; mode 3: 5617)
- $T_s$ : Time duration of OFDM Symbol
- $T_g$ : Time duration of guard-interval
- $T_u$ : Time duration of useful part of a symbol
- $f_c$ : RF-signal center frequency
- $K_c$ : Carrier number corresponding to the RF-signal center frequency (mode 1: 702; mode 2: 1404; mode 3: 2808)
- $c(n,k)$ : Complex signal-point vector corresponding to symbol number  $n$  and carrier number  $k$
- $s(t)$ : RF signal

$$s(t) = \text{Re} \left\{ e^{j2\pi f_c t} \sum_{n=0}^{\infty} \sum_{k=0}^{K-1} c(n, k) \Psi(n, k, t) \right\}$$

#### Provided

$$\Psi(n, k, t) = \begin{cases} e^{j2\pi \frac{k-K_c}{T_u} (t-T_g-nT_s)} & nT_s \leq t < (n+1)T_s \\ 0 & t < nT_s, \quad (n+1)T_s \leq t \end{cases}$$

Note that the center frequency for digital terrestrial Television broadcasting is stipulated by the RF frequency corresponding to  $K_c$ .

(Ordinance)

### 3.14.2 Insertion of a guard interval

A guard interval, the latter part of the IFFT (Inverse Fast Fourier Transform) data output for the specified duration, is added without any modification to the beginning of the effective symbol. This operation is shown in Fig. 3-33.

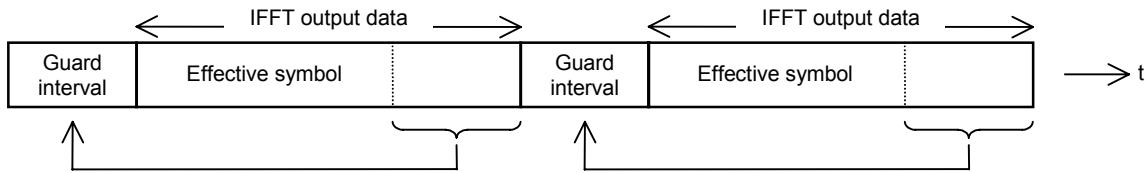

Fig. 3-33: Insertion of a Guard Interval

(Ordinance)

## 3.15 TMCC signal (Transmission and Multiplexing Configuration Control)

The information coding scheme and transmission system for the transmission and multiplexing configuration control signal (TMCC signal) are stipulated in this section.

### 3.15.1 Overview

The TMCC signal is used to convey information on how the receiver is to perform demodulation of information such as the hierarchical configuration and the OFDM-segment transmission parameters. The TMCC signal is transmitted by means of the TMCC carrier stipulated in Section 3.13.

### 3.15.2 Assignment of TMCC carrier bits

Table 3-20 shows the assignment of 204 TMCC carrier bits  $B_0$  to  $B_{203}$ .

Table 3-20: Bit Assignment

$B_0$	Reference for differential demodulation
$B_1 - B_{16}$	Synchronizing signal ( $w_0 = 0011010111101110$ , $w_1 = 1100101000010001$ )
$B_{17} - B_{19}$	Segment type identification (differential: 111; synchronous: 000)
$B_{20} - B_{121}$	TMCC information (102 bits)
$B_{122} - B_{203}$	Parity bit

(Ordinance)

### 3.15.3 References for differential demodulation

The reference amplitude and phase for differential demodulation are given by  $W_i$  in Table 3-17.

(Ordinance)

### 3.15.4 Synchronizing signal

The synchronizing signal consists of a 16-bit word and takes one of two forms: one with  $w_0 = 0011010111101110$  and the other with  $w_1 = 1100101000010001$  obtained by inverting each bit of  $w_0$ . One of  $w_0$  and  $w_1$  is transmitted alternately for each frame. The following shows an example of synchronizing signal transmission:

Table 3-21: Example of Synchronizing Signal

Frame No.	Synchronizing signal
1	0011010111101110
2	1100101000010001
3	0011010111101110
4	1100101000010001
:	:

Note: Frame numbers are assigned for convenience of description.

(Ordinance)

[Description]

A synchronizing signal is designed to establish synchronism between transmission and reception of a TMCC signal and OFDM frame. To prevent false synchronization lock caused by the TMCC-information bit pattern matching that of the synchronizing signal, the polarity of the synchronizing signal is inverted every frame. Because TMCC information itself is not inverted every frame, it is possible to prevent false synchronization lock by means of inversion of the synchronizing-signal polarity.

### 3.15.5 Segment type identification

This signal is used to determine whether a segment is a differential or synchronous modulation and consists of a 3-bit word. “111” and “000” are assigned to this signal for a differential and synchronous modulation, respectively.

(Ordinance)

[Description]

The number of TMCC carriers varies depending on the segment format. There is only one TMCC carrier if the partial-reception segment belongs to one of the synchronous modulations. Even in this case, to ensure reliable decoding, three bits are assigned to the identification signal such that the code-to-code distance becomes maximal when these bits are inverted.

### 3.15.6 TMCC information

TMCC information assists the receiver in demodulating and decoding various information, including the system identification, the indicator of transmission-parameter switching, the start flag for emergency-alarm broadcasting, the current information, and the next information.

The current information represents the current hierarchical configuration and transmission parameters, while the next information includes the transmission parameters following switching. Prior to the countdown for switching (see Section 3.15.6.2), the next information can be specified or changed at the desired time. However, no changes can be made during countdown.

Tables 3-22 and 3-23 show the TMCC-information bit assignment and the transmission parameters included in next information, respectively.

The phase-shift-correction value for connected segment transmission is control information for ISDB for terrestrial sound broadcasting (ISDB-T<sub>SB</sub>) that uses the same transmission system as ISDB-T. Of the 102 bits of TMCC information, 90 bits have been defined as of today. The remaining 12 bits are reserved for future expansion. For operation, all these bits are stuffed with 1s.

Table 3-22: TMCC Information

Bit assignment	Description	Remarks	
B <sub>20</sub> – B <sub>21</sub>	System identification	See Table 3-24.	
B <sub>22</sub> – B <sub>25</sub>	Indicator of transmission-parameter switching	See Table 3-25.	
B <sub>26</sub>	Start flag for emergency-alarm broadcasting	See Table 3-26.	
B <sub>27</sub>	Partial-reception flag	See Table 3-27.	
B <sub>28</sub> – B <sub>40</sub>	Current information	See Table 3-23.	
B <sub>41</sub> – B <sub>53</sub>			Transmission-parameter information for hierarchical layer A
B <sub>54</sub> – B <sub>66</sub>			Transmission-parameter information for hierarchical layer B
B <sub>67</sub>	Partial-reception flag	See Table 3-27.	
B <sub>68</sub> – B <sub>80</sub>	Next information	See Table 3-23.	
B <sub>81</sub> – B <sub>93</sub>			Transmission-parameter information for hierarchical layer A
B <sub>94</sub> – B <sub>106</sub>			Transmission-parameter information for hierarchical layer B
B <sub>107</sub> – B <sub>109</sub>	Phase-shift-correction value for connected segment transmission <sup>(Note)</sup>	1 for all bits	
B <sub>110</sub> – B <sub>121</sub>	Reserved	1 for all bits	

Note: Used for ISDB for terrestrial sound broadcasting

(Notification)

Table 3-23: Contents of Transmission-Parameter Information

Description	Number of bits	Remarks
Carrier modulation scheme	3	See Table 3-28.
Convolutional-coding rate	3	See Table 3-29.
Interleaving length	3	See Table 3-30.
Number of segments	4	See Table 3-31.

(Notification)

### 3.15.6.1 System identification

Two bits are assigned to the signal provided for system identification purposes. “00” and “01” are employed to represent a system based on this specification and that for ISDB-T<sub>SB</sub> that uses the same transmission system as ISDB-T, respectively. The remaining values are reserved. Table 3-24 shows the contents of the system identification bits.

Table 3-24: System Identification

B <sub>20</sub> – B <sub>21</sub>	Meaning
00	System based on this specification
01	System for ISDB-T <sub>SB</sub>
10, 11	Reserved

(Notification)

### 3.15.6.2 Indicator of transmission-parameter switching

To switch between sets of transmission parameters, the contents of the indicator of transmission-parameter switching are counted down in order to inform the receiver of transmission-parameter switching and adjust the timing accordingly. These indicator bits are normally set to “1111.” However, when it is necessary to switch parameters, the countdown starts 15 frames prior to switching, thus decrementing the contents of these bits by 1 every frame. Note that when the contents reach “0000,” they must be set back to “1111.”

Switching must be performed in synchronization with the next frame that outputs “0000.” That is, a new set of transmission parameters apply, starting with the frame with which the contents of the bits are set back to “1111.” Table 3-25 shows the meaning of each count of the indicator of transmission-parameter switching.

Table 3-25: Indicator of Transmission-Parameter Switching

B <sub>22</sub> – B <sub>25</sub>	Meaning
1111	Normal value
1110	15 frames prior to switching
1101	14 frames prior to switching
1100	13 frames prior to switching
:	:
0010	3 frames prior to switching
0001	2 frames prior to switching
0000	1 frame prior to switching

(Notification)

#### [Description]

When switching any of the transmission parameters and flags contained in the current information and the next information in Table 3-22 (partial-reception flag, carrier modulation scheme, convolutional-coding rate, interleaving length, and the number of segments), the contents of the 4-bit indicator of transmission parameter switching shown in Table 3-25 are counted down. When switching only the start flag for emergency-alarm broadcasting, the contents of the indicator of transmission parameter switching are not counted down.

### 3.15.6.3 Start flag for emergency-alarm broadcasting

The content of the start flag must be 1 and 0 when the receiver startup is and is not controlled, respectively. Table 3-26 shows the meaning of the flag content in each case.

Table 3-26: Start Flag for Emergency-Alarm Broadcasting

B <sub>26</sub>	Meaning
0	No startup control
1	Startup control available

(Notification)

### 3.15.6.4 Partial-reception flag

The content of the partial-reception flag must be 1 and 0 when the segment at the center of the transmission band is and is not used for partial reception, respectively. Table 3-27 shows the meaning of the flag content in each case.

When segment No .0 is used for partial reception, hierarchical layer A in Table 3-22 must be assigned to that segment. Note that the content of this flag is 1 if there is no next information.

Table 3-27: Partial-Reception Flag

B <sub>27</sub> /B <sub>67</sub>	Meaning
0	No partial reception
1	Partial reception available

(Notification)

### 3.15.6.5 Carrier modulation scheme

Table 3-28 shows the meanings of carrier modulation scheme bits.

Note that the content of these bits is 111 for an unused hierarchical layer, or when there is no next information.

Table 3-28: Carrier Modulation Scheme

B <sub>28</sub> –B <sub>30</sub> /B <sub>41</sub> –B <sub>43</sub> /B <sub>54</sub> –B <sub>56</sub> B <sub>68</sub> –B <sub>70</sub> /B <sub>81</sub> –B <sub>83</sub> /B <sub>94</sub> –B <sub>96</sub>	Meaning
000	DQPSK
001	QPSK
010	16QAM
011	64QAM
100–110	Reserved
111	Unused hierarchical layer

(Notification)

With a TMCC signal, the meanings of all sets of bit contents are the same for all three hierarchical layers. When signals of two hierarchical layers or fewer are transmitted, the content of these bits for vacant hierarchical layer(s) must be 111. Note also that the content of these bits must be 111 if there is no next information, as when broadcasting ends.

### 3.15.6.6 Convolutional-coding rate

Table 3-29 shows the meanings of contents of convolutional-coding-rate bits.

Note that the content of these bits is 111 for an unused hierarchical layer or when there is no next information.

Table 3-29: Convolutional-Coding Rate

B <sub>31</sub> –B <sub>33</sub> /B <sub>44</sub> –B <sub>46</sub> /B <sub>57</sub> –B <sub>59</sub> B <sub>71</sub> –B <sub>73</sub> /B <sub>84</sub> –B <sub>86</sub> /B <sub>97</sub> –B <sub>99</sub>	Meaning
000	1/2
001	2/3
010	3/4
011	5/6
100	7/8
101–110	Reserved
111	Unused hierarchical layer

(Notification)

### 3.15.6.7 Interleaving length

Table 3-30 shows the meanings of contents of time-interleaving-length bits. This information represents time interleaving length I shown in Table 3-12.

Note that the content of these bits is 111 for an unused hierarchical layer or when there is no next information.

Table 3-30: Interleaving Length

B <sub>34</sub> –B <sub>36</sub> /B <sub>47</sub> –B <sub>49</sub> /B <sub>60</sub> –B <sub>62</sub> B <sub>74</sub> –B <sub>76</sub> /B <sub>87</sub> –B <sub>89</sub> /B <sub>100</sub> –B <sub>102</sub>	Meaning (value I)
000	0 (Mode 1), 0 (Mode 2), 0 (Mode 3)
001	4 (Mode 1), 2 (Mode 2), 1 (Mode 3)
010	8 (Mode 1), 4 (Mode 2), 2 (Mode 3)
011	16 (Mode 1), 8 (Mode 2), 4 (Mode 3)
100–110	Reserved
111	Unused hierarchical layer

(Notification)

### 3.15.6.8 Number of segments

Table 3-31 shows the meanings of contents of segments bits. Note that the content of these bits is 1111 for an unused hierarchical layer or when there is no next information.

Table 3-31: Number of Segments

B <sub>37</sub> –B <sub>40</sub> /B <sub>50</sub> –B <sub>53</sub> /B <sub>63</sub> –B <sub>66</sub> B <sub>77</sub> –B <sub>80</sub> /B <sub>90</sub> –B <sub>93</sub> /B <sub>103</sub> –B <sub>106</sub>	Meaning
0000	Reserved
0001	1 segment
0010	2 segment
0011	3 segment
0100	4 segment
0101	5 segment
0110	6 segment
0111	7 segment
1000	8 segment
1001	9 segment
1010	10 segment
1011	11 segment
1100	12 segment
1101	13 segment
1110	Reserved
1111	Unused hierarchical layer

(Notification)

### 3.15.6.9 Channel-coding scheme

B<sub>20</sub> to B<sub>121</sub> of TMCC information are error-correction coded by means of the shortened code (184,102) of the difference cyclic code (273,191). The following shows the generating polynomial of the (273,191) code:

$$g(x) = x^{82} + x^{77} + x^{76} + x^{71} + x^{67} + x^{66} + x^{56} + x^{52} + x^{48} \\ + x^{40} + x^{36} + x^{34} + x^{24} + x^{22} + x^{18} + x^{10} + x^4 + 1$$

(Ordinance)

[Description]

Because TMCC information is used to specify transmission parameters and control the receiver operation, it must be transmitted with higher reliability than program signals. Due to the difficulties involved with a receiver using the same concatenated-code decoding circuit for TMCC information and program signals, and in consideration of the fact that the use of block code is advantageous due to its shorter processing time, the shortened code (184,102) of the difference cyclic code (273,191) is used as the error-correction code for TMCC information. Note also that the same TMCC signals are transmitted by means of multiple carriers. Therefore, it is possible to reduce the required C/N by simply adding these signals, thus ensuring improved reception performance. These error-correction techniques and the addition process make it possible to receive TMCC signals at a lower C/N than for program signals.

Note also that, by excluding the synchronizing signal and segment type identification from the group of bits checked for errors, the contents of all TMCC carrier bits are the same, which makes it possible to determine the content of each bit, including a parity bit, by determining the contents of the majority of the carriers.

#### **3.15.6.10 Modulation scheme**

TMCC carriers must be modulated through DBPSK (see Section 3.13.3).

## Chapter 4: Frequency Utilization Requirements

### 4.1 Frequency bandwidth

A frequency bandwidth of 5.7 MHz must be used for digital terrestrial television broadcasting. The carrier frequency must be the center frequency of the frequency bandwidth.

(Ordinance)

[Description]

The frequency bandwidth must be 5.7 MHz when the OFDM carrier bandwidth is 5.572..MHz with 4-kHz spacings between carrier frequencies in Mode 1. This bandwidth must apply regardless of which mode is chosen, and has been selected to ensure that the bandwidth of 5.610 MHz has some margin to determine that each carrier of the uppermost and lowermost in the 5.572..MHz bandwidth includes 99% of energy.

The center frequency is the frequency of the carrier at the center, among an odd number of OFDM carriers.

### 4.2 Permissible transmission-frequency deviation

The permissible transmission-frequency deviation must be 1 Hz.

Note: A deviation of 500 Hz is allowed if the Minister for Public Management, Home Affairs, Posts and Telecommunications approves it on the grounds that it will not substantially hinder the efficient use of radio waves.

(Ordinance)

### 4.3 IFFT sampling frequency and permissible deviation

The IFFT sampling frequency for use with OFDM for digital terrestrial television broadcasting must be as follows:

$f_s = 8,126,984$  Hz

Note also that the permissible deviation must be  $\pm 0.3$  ppm.

(Ordinance)

[Description]

This deviation has been determined to ensure that the frequency deviation (caused by FFT sample frequency error) of the carrier at each end of the bandwidths is 1 Hz or less.

An IFFT sampling frequency of 512/63 MHz, a theoretical sample frequency, may be used if the permissible deviation requirement is met.

#### 4.4 Transmission-spectrum mask

The transmission-spectrum limit mask is specified as shown below in Fig. 4-1. The related break points for the spectrum mask are listed in Table 4-1.

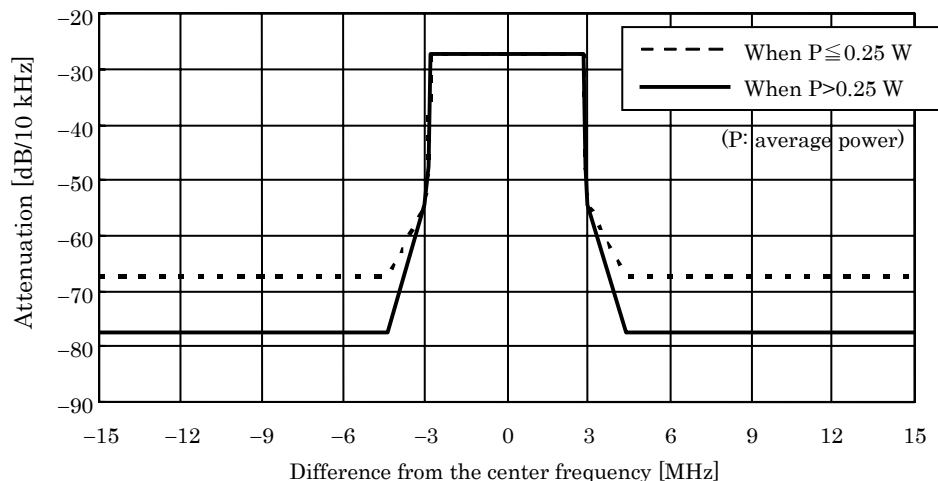

Fig. 4-1 Transmission-spectrum limit mask for digital terrestrial television broadcasting

Table 4-1 Breakpoints for transmission-spectrum mask

Difference from the center frequency (MHz)	Attenuation relative to average power P (dB/10 kHz)	Type of stipulation
±2.79	-27.4	Upper limit
±2.86	-47.4	Upper limit
±3.00	-54.4	Upper limit
±4.36	-77.4*	Upper limit

\* If the frequency corresponding to an adjacent channel number (the channel number between 13 and 62 that is one number different from the channel number of the television broadcasting corresponding to the allocated frequency in the Plan for the Available Frequencies Allocated to Broadcasting stipulated in item (ii) of paragraph (2) of Article 7 of the Radio Law) is not used for standard television broadcasting (excluding digital broadcasting and restricted to the effective radiation power that is less than ten times the own effective radiation power) within the own broadcasting area, the following specifications should be applied:

- $(73.4+10\log P)$  dB/10 kHz in the case of radio equipment whose transmission power is more than 0.25 W and equal to or less than 2.5 W;

-67.4 dB/10 kHz in the case of radio equipment whose transmission power is 0.25 W or less.

Note: For the adjacent channels of radio equipment that amplifies multiple waves together, an attenuation of -27.4 dB/10 kHz relative to average power P can be set as the upper limit regardless of the above table.

(Ministerial Ordinance)

The above specifications are accompanied with transitional measures (supplementary provisions to the Radio Equipment Rules--Ministerial Ordinance No. 119 issued by the MIC (Ministry of Internal affairs and Communications) in 2005).

#### Explanation

If an adjacent channel is used for standard television broadcasting (excluding digital broadcasting and restricted to the effective radiation power that is less than ten times the own effective radiation

power) within the own broadcasting area, the solid line of Fig. 4-1 (attenuation relative to average power P is -77.4 dB/10 kHz at the frequencies of +/-4.36 MHz from the center frequency) should be applied regardless of the value of P.

#### 4.5 Maximum permitted power level of spurious emission or unwanted emission

The power supplied to antenna transmission line	Maximum permitted power level of spurious emission in out-of-band domain	Maximum permitted power level of unwanted emission in spurious domain
Above 25 W	20 mW or less, and 60 dB* lower than the average power of basic frequency	12 mW or less, and 60 dB lower than the average power of basic frequency
Above 1 W, and 25 W or less	25 µW or less	25 µW or less
1 W or less	100 µW or less	

\* For the maximum permitted power level of spurious emission in the out-of-band region for transmission equipment whose transmission power exceeds 8 kW, the values specified in section 4.4 shall be used.

(Table extracted from the Radio Equipment Rules)

The above specifications are accompanied with transitional measures (supplementary provisions to the Radio Equipment Rules--Ministerial Ordinance No. 119 issued by the MIC (Ministry of Internal affairs and Communications) in 2005).

# Appendix: Operation Guidelines for Digital Terrestrial Television Broadcasting



## Appendix: Operation Guidelines for Digital Terrestrial Television Broadcasting

### Contents

Chapter 1: Objective .....	69
Chapter 2: Transmission-Spectrum Arrangement .....	70
2.1 OFDM carrier number corresponding to the ISDB-T center frequency .....	70
2.2 Frequency assignment .....	70
Chapter 3: Operational Guidelines for Hierarchical Transmission .....	71
3.1 Outline.....	71
3.2 Multiplexed signals for hierarchical transmission .....	72
3.2.1 Multiplexing PAT, NIT, and CAT for hierarchical transmission .....	72
3.2.2 Notes on multiplexing transmission.....	73
3.2.3 Multiplexing PMT.....	73
3.2.4 Multiplexing PCR packets at the partial-reception hierarchical layer .....	75
3.3 Channel-coding scheme for hierarchical transmission.....	78
3.4 Video coding scheme .....	82
3.4.1 Constraints of video coding parameter .....	82
3.4.2 Constraints of still picture coding parameter.....	82
Chapter 4: Guidelines for Synchronization.....	84
4.1 Synchronization for SFN.....	84
4.1.1 Transmission frequency.....	84
4.1.2 IFFT sampling frequency .....	84
4.1.3 OFDM signals .....	84
Chapter 5: Signal Transmission Scheme to STL/TTL.....	85
5.1 Types of interface point.....	85
5.2 Types of synchronization scheme .....	86
5.2.1 Complete synchronization.....	86
5.2.2 Slave synchronization.....	86
5.2.3 Reference synchronization .....	86
5.2.4 Synchronization conversion (Quasi-synchronization).....	86

5.3	Assumed broadcasting network types.....	88
5.3.1	Network construction without having to consider SFN conditions .....	89
5.3.2	Network operation necessary to consider the SFN condition.....	90
5.4	Usage examples of synchronization method considering SFN .....	91
5.4.1	Interface point and synchronization method when considering SFN.....	91
5.4.2	Usage examples of synchronization method corresponding to the broadcasting network.....	92
5.5	Additional information necessary for re-multiplexing TS transmission.....	96
5.5.1	Types of additional information.....	96
5.5.2	Multiplex to dummy byte part.....	97
5.5.3	Multiplex to invalid hierarchy IIP (ISDB-T_Information_Packet).....	100
Chapter 6:	Operational guidelines for AC data transmission .....	109
6.1	Determination of broadcasting TS multiplex positions .....	109
6.2	Multiplexing on dummy byte part.....	109
6.2.1	Multiplex position .....	109
6.2.2	Syntax for multiplexing AC data on dummy byte part.....	109
6.2.3	Mapping of AC data to OFDM carriers .....	109
6.3	Multiplexing on invalid hierarchy .....	111
6.3.1	Multiplex position.....	111
6.3.2	Syntax for multiplexing AC data on invalid hierarchy.....	111
6.3.3	Data arrangement on multiplex frames and TS packets .....	113
6.3.4	Mapping to OFDM carriers .....	115
6.4	Considerations in multiplexing AC data to broadcasting TS.....	116
6.4.1	Considerations in the order of AC data carriers.....	116

## Chapter 1: Objective

This standard presents as guidelines those operational recommendations for digital terrestrial television broadcasting in relation to program broadcasting and transmission equipment.

## Chapter 2: Transmission-Spectrum Arrangement

### 2.1 OFDM carrier number corresponding to the ISDB-T center frequency

As shown in Chapter 4 of this document, the ministerial ordinance stipulates that the carrier-wave frequency must be the center frequency of the frequency bandwidth.

Because ISDB-T program signals consist of an odd number of OFDM carriers regardless of the mode, the following numbers must be assigned to the OFDM carrier that corresponds to the carrier-wave frequency.

Table 2-1: OFDM Carrier Number Corresponding to the Carrier-Wave Frequency

Transmission mode	Mode 1	Mode 2	Mode 3
Carrier number corresponding to the center frequency	702	1404	2808

OFDM carrier number when 0 is assigned to the lowermost carrier along the RF frequency axis

### 2.2 Frequency assignment

The ISDB-T program-signal carrier-wave frequency must be shifted upward by 1/7 MHz (142,857 Hz) from the center frequency used in the current Television-channel plan.

Table 2-2: UHF Channels and ISDB-T Program-Signal Carrier-Wave Frequencies

Number of UHF channels	Channel 13	Channel 14	.....	Channel 62
Carrier-wave frequency	$473 + 1/7$ MHz = 473.142857MHz	$479 + 1/7$ MHz = 479.142857MHz	.....	$767 + 1/7$ MHz = 767.142857MHz

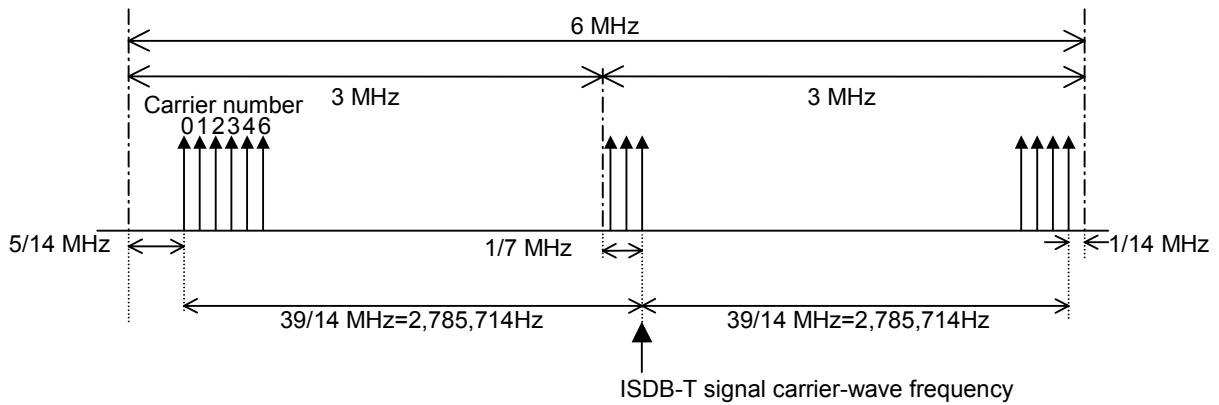

Fig. 2-1: Example of OFDM Signal Arrangement

## Chapter 3: Operational Guidelines for Hierarchical Transmission

### 3.1 Outline

ISDB-T allows switching between transmission systems and the use of multiple such systems. This allows the stable transmission of program signals to mobile receivers, portable receivers, and stationary receivers in exchange for large-volume transmission.

For example, when 64QAM and 7/8 are selected as the modulation scheme and error correction, respectively, it is possible to achieve a transmission capacity of 20 Mbps or more per 6 MHz. However, in order to provide service to mobile receivers and portable receivers, we believe that hierarchical transmission, in which DQPSK or 16QAM is employed as the modulation scheme for part of the bandwidth, is advantageous.

Example in which hierarchical transmission is not used  
(high-volume data transmission to a stationary receiver)

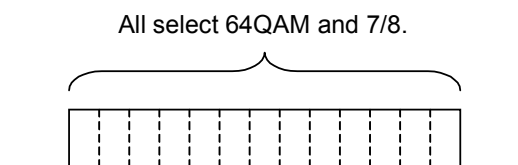

Example in which three hierarchical levels are used  
(service provided for stationary and portable receivers, as well as partial-reception receivers)

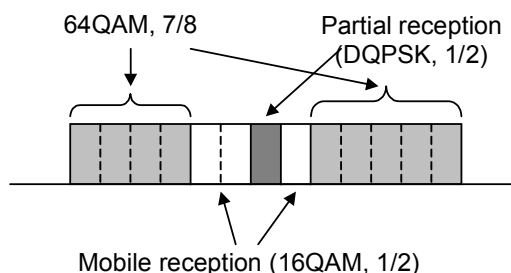

The figures shown above are conceptual drawings made without taking frequency interleaving into consideration.

Fig. 3-1: Example of a Hierarchical Transmission System

## 3.2 Multiplexed signals for hierarchical transmission

### 3.2.1 Multiplexing PAT, NIT, and CAT for hierarchical transmission

- PAT, NIT, and CAT, among transmission control signals, shall be basically transmitted with the hierarchical layers shown in Table 3-1.

Table 3-1: Hierarchical Layers for Transmitting PAT, NIT, and CAT

Condition		Hierarchical layer for transmitting PAT, NIT, and CAT*1
1	Broadcasting with no partial reception	Multiplexed into the robustest layer*2
2	Broadcasting with partial reception	(1) Multiplexed into the layer for partial reception*2
		(2) Multiplexed into not only the layer for partial reception but also another layer if this layer is robust than the layer for partial reception*2

\*1: CAT is required for partial reception.

\*2: If the transmission in the hierarchical layers shown above is difficult, exceptional operations are also admitted. In this case, however, detailed operational provisions shall be set separately to ensure that services in each layer will be received successfully.

Table 3-2: Robustness of Hierarchical Layers

Ranking of hierarchical layers	Strong ← ----- → Weak																			
	1	2	3	4	5	6	7	8	9	10	11	12	13	14	15	16	17	18	19	20
Modulation scheme	DQ	Q	DQ	Q	DQ	Q	DQ	Q	DQ	Q	16QAM					64QAM				
Inner-code coding rate	1/2	1/2	2/3	2/3	3/4	3/4	5/6	5/6	7/8	7/8	1/2	2/3	3/4	5/6	7/8	1/2	2/3	3/4	5/6	7/8

DQ: DQPSK

Q: QPSK

QPSK is preferable to DQPSK in terms of the required C/N. However, DQPSK offers better performance in the event of time variations under mobile-reception conditions. Therefore, DQPSK is robust than QPSK.

### 3.2.2 Notes on multiplexing transmission

When transmission control signals are transmitted with multiple hierarchical layers, including those for partial reception, the continuity of the continuity\_counter for transport-stream packets conveying transmission control signals must be taken into consideration.

Because this counter is continuous even for narrow-band receivers that reproduce only the hierarchical layer for partial reception, duplicate packets must be used\*1.

For this reason, when transmission control signals are multiplexed into multiple hierarchical layers, as in “Condition 2 (2)” of Table 3-1, duplicate packet transmission must be used. Note, however, that if different time interleaving lengths are specified for the partial-reception hierarchical layer and the robustest hierarchical layer, it is necessary to exercise caution when duplicate packet transmission is used.

\*1: A duplicate packet, as defined in “MPEG-2 systems,” is designed to send two TSPs (transport packets) successively within the same PID. Note that the contents of these TSPs other than PCR are the same within the transport stream. Note also that the contents of the continuity counter are the same for both of these TSPs.

### 3.2.3 Multiplexing PMT

PMT must be transmitted with the following hierarchical layers:

Table 3-3: Hierarchical Layers for Transmitting PMT

Condition		Hierarchical layer for transmitting PAT
1	Partial-reception service	Transmitted with the hierarchical layer for partial reception
2	When a hierarchical transmission descriptor is used within PMT*1	PMT should be transmitted at the robustest layer among those transmitting elementary streams (hereinafter referred to as “ESs”). However, PMT may be transmitted with the other hierarchical layer if it has a more robust ranking of the layer than the layer specified above.
3	Service other than the above	PMT should be transmitted with one of the hierarchical layers transmitting ESs. It may also be transmitted with another hierarchical layer if it has a more robust ranking of the layer.

\*1: Services such as those in which video and other service qualities are changed in steps, in accordance with the reception status

As for Condition 1, the partial-reception service PMT should always be transmitted with the hierarchical layer for partial reception. This requirement must be met for narrow-band receivers that receive only the hierarchical layer for partial reception. Therefore, PMT must be transmitted with this hierarchical layer.

With those services presented as Condition 2, in which service qualities can be changed in steps in accordance with the reception status through the use of the hierarchical transmission descriptor which is used in PMT, it is necessary to ensure that PMT can be received even under adverse reception conditions in which service qualities may be degraded. For this reason, we have concluded that the one with robustest of those layers transmitting ESs, or another layer that has even robustest must be used to transmit PMT. For example, if there are service ESs in the weakest hierarchical layer and the medium hierarchical layer, as with Combination “a” in Table 3-4, PMT must be transmitted with either the medium layer or the robustest layer.

In Condition 3, a service can be provided only when all service-multiplexed ESs are received. In this case, PMT should not be sent with a weaker hierarchical layer than ES-transmission hierarchical layers. As with Combination “j” in Table 3-4, for example, when service ESs are included in the medium layer and the robustest layer, transmission of PMT using the weakest hierarchical layer can make it impossible to receive that service, depending on the reception status, even if all ESs are successfully received.

Table 3-4: ES- and PMT-Transmission Hierarchical Layers<sup>\*1</sup>

Condition	Combination	ES-transmission hierarchical layer			PMT-transmission hierarchical layer		
		Weakest	Medium	Robustest	Weakest	Medium	Robustest
2 <sup>*2</sup>	a	●	●			●	●
	b	●		●			●
	c		●	●			●
3	d	●			●	●	●
	e		●			●	●
	f	●	●		●	●	●
	g			●			●
	h	●		●	●	●	●
	i		●	●		●	●
	j	●	●	●	●	●	●

\*1: With provisional digital terrestrial television broadcasting, up to three hierarchical layers can be transmitted. These layers are classified into three groups, “Weakest,” “Medium,” and “Robustest”.

\*2: A hierarchical transmission descriptor can be used in up to two hierarchical layers.

### 3.2.4 Multiplexing PCR packets at the partial-reception hierarchical layer

When a service is provided using the partial-reception hierarchical layer, PCR packets for this service must be transmitted in accordance with Table 3-5.

To reduce power consumption, the rate at which a single-segment receiver reproduces TS is likely to be lower than that for a 13-segment receiver. Therefore, the intervals at which TS packets are reproduced by the single-segment receiver do not always match those at which TS packets at the partial-reception hierarchical layer are reproduced by the 13-segment receiver, resulting in PCR jitter (see Fig. 3-2).

To prevent this problem, limitations are imposed on PCR transmission as shown in Table 3-5. These limitations ensure that PCR packets are reproduced by single- and 13-segment receivers at equal intervals, thus eliminating the need for a PCR jitter correction step, although some difference in offset is produced.

Table 3-5: Regulations for PCR-Packet Transmission at the Partial-Reception Hierarchical Layer

Mode	PCR-packet transmission regulations
Mode 1	For the duration of a single multiplex frame, only one PCR packet must be multiplexed per service, and the multiplexing position must remain constant for all multiplex frames (see Fig. 3-3).
Mode 2	For the duration of a single multiplex frame, two PCR packets must be multiplexed per service at the same intervals (see Fig. 3-4).
Mode 3	For the duration of a single multiplex frame, four PCR packets must be multiplexed per service at the same intervals (see Fig. 3-5).

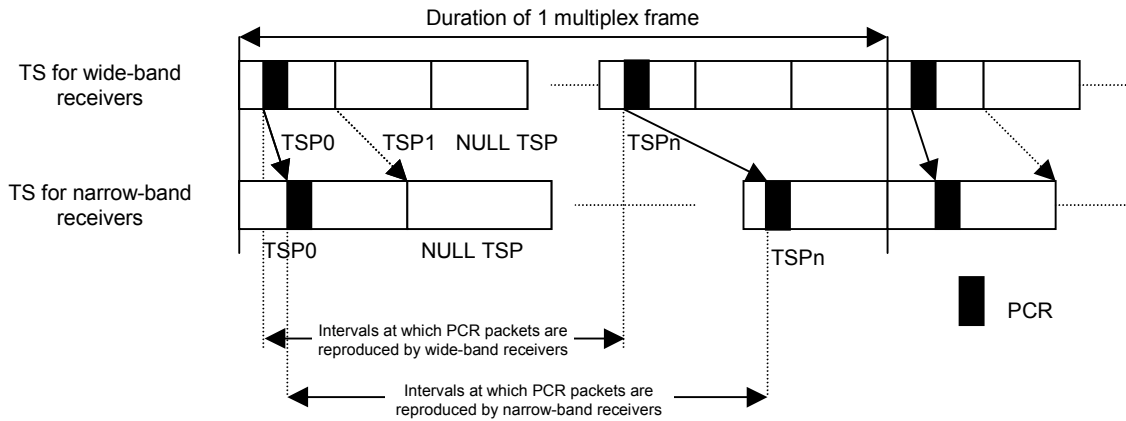

Fig. 3-2: TSs Reproduced by Wide- and Narrow-Band Receivers (No Limitations on PCR Transmission)

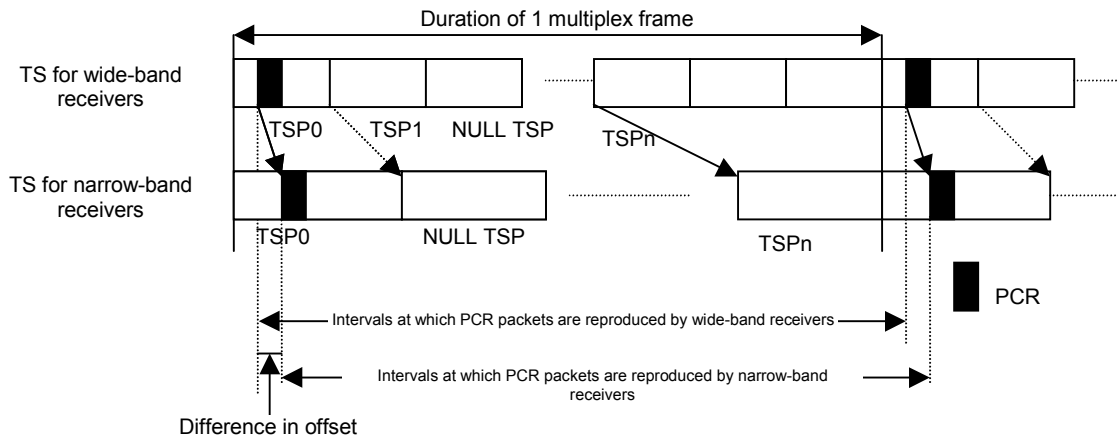

Fig. 3-3: PCR-Packet Transmission in Mode 1

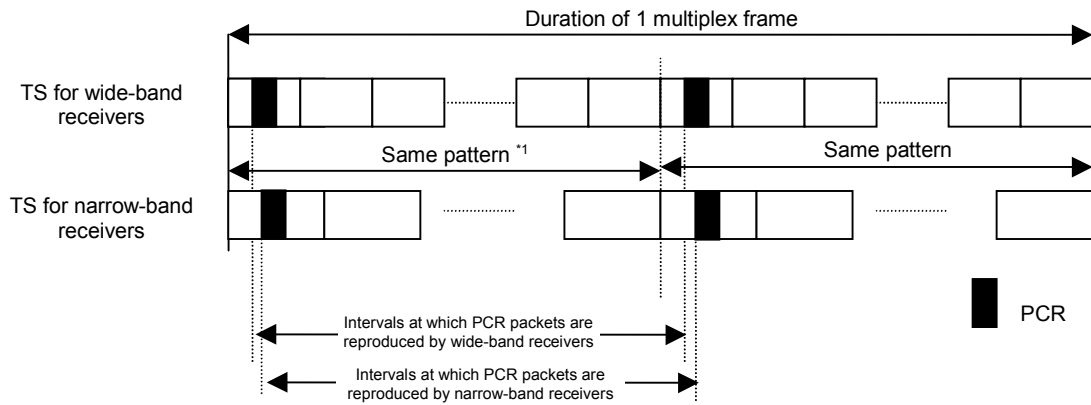
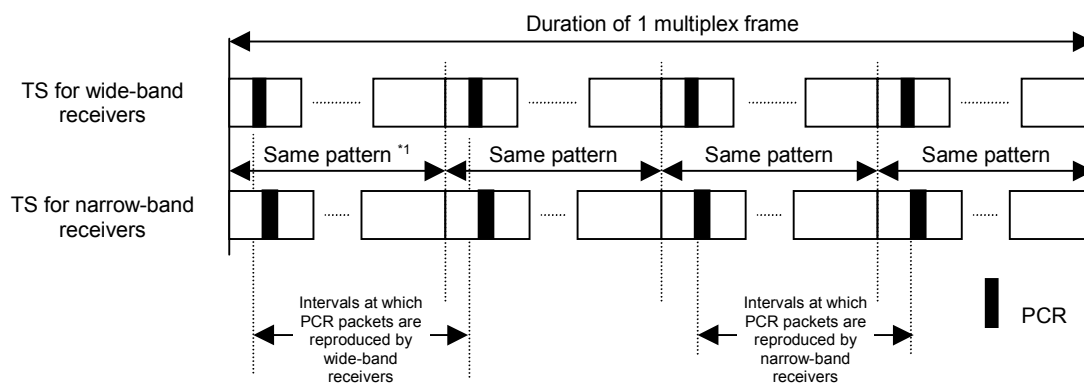

Fig. 3-4: PCR-Packet Transmission in Mode 2



\*1 “Same pattern” in the figures indicates that each PCR packet is arranged in the same relative position within the stream.

Fig. 3-5: PCR-Packet Transmission in Mode 3

### 3.3 Channel-coding scheme for hierarchical transmission

TS is divided into TSPs, each of which is assigned to the specified hierarchical layer, as described in Section 3.4 of Chapter 3 in ARIB STD-B31. Switching between hierarchical layers is performed every 204 bytes (starting with the byte next to the TS synchronization byte (47H)).

The following Fig. 3-6 and 3-7 show examples of the clock periods required by the channel coding in which two hierarchical layers are available (one layer modulated through DQPSK 1/2 and with 5 segments, and the other modulated through 64QAM 7/8 and with 8 segments) and a guard interval of 1/8 is selected. Note that “Fs” in the figure represents the FFT sampling clock. Fig. 3-8 and 3-9 show examples of the signal processes for time interleaving and delay adjustment.

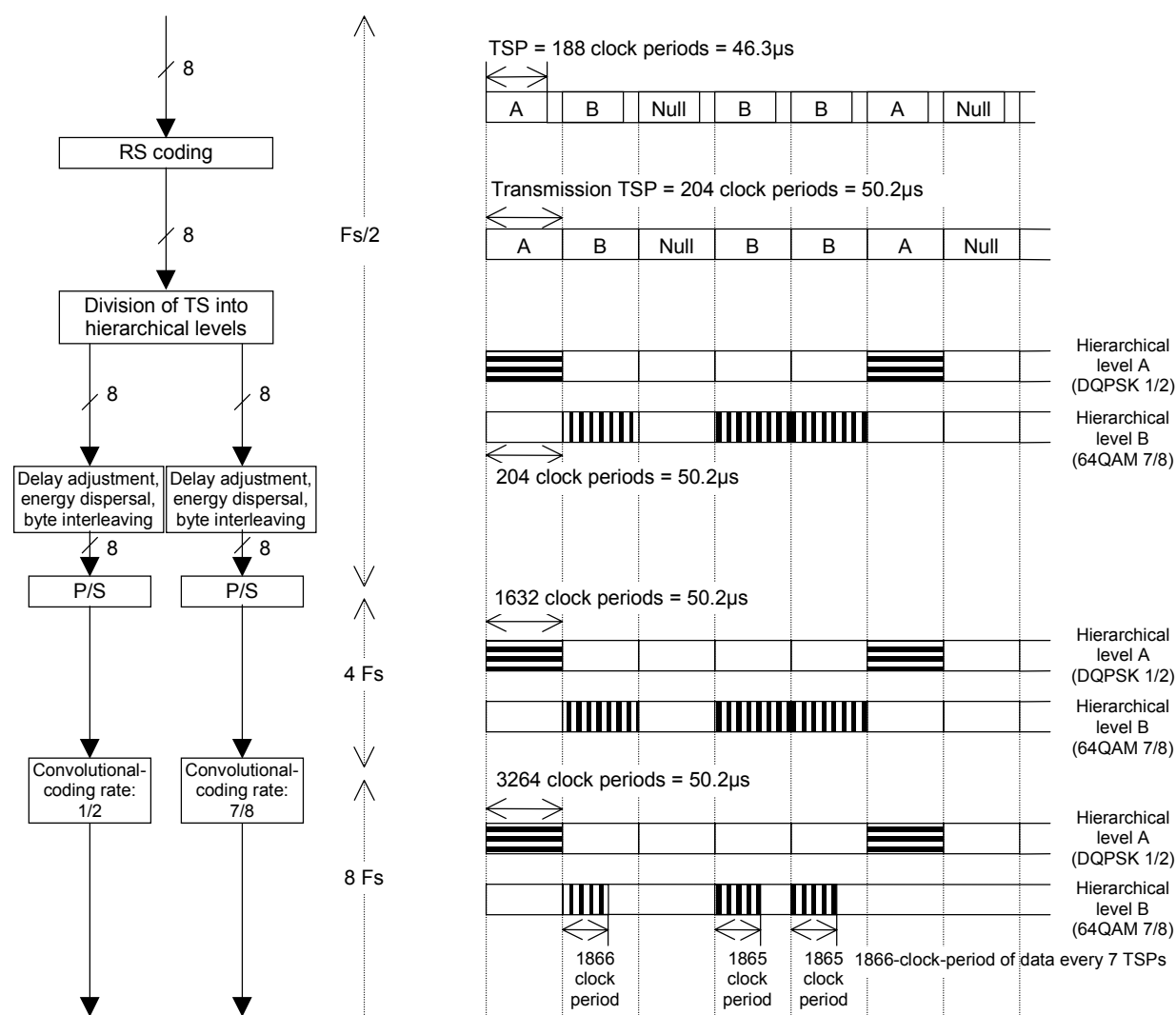

Fig. 3-6: Example of a Signal Transmission System (1)

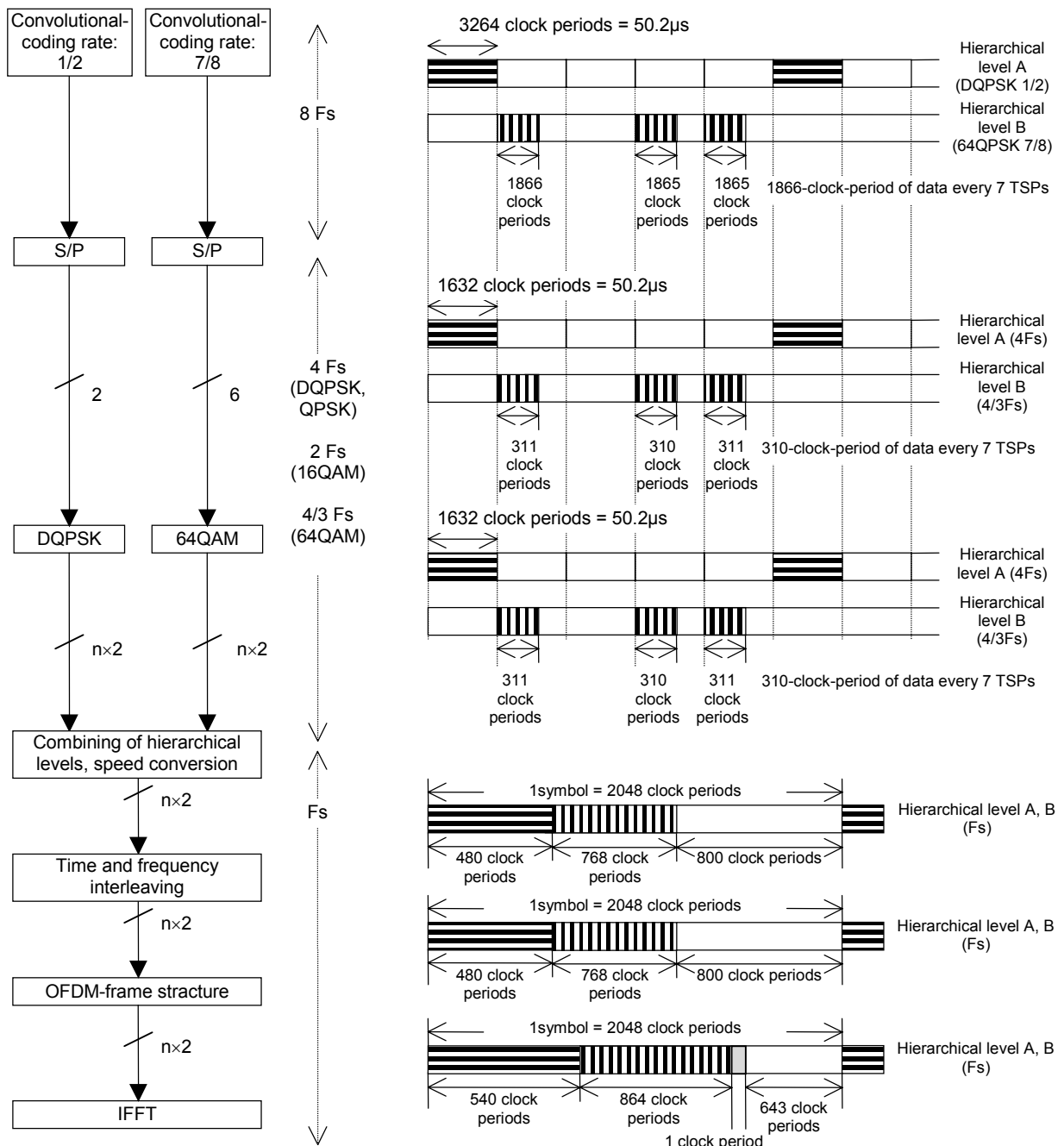
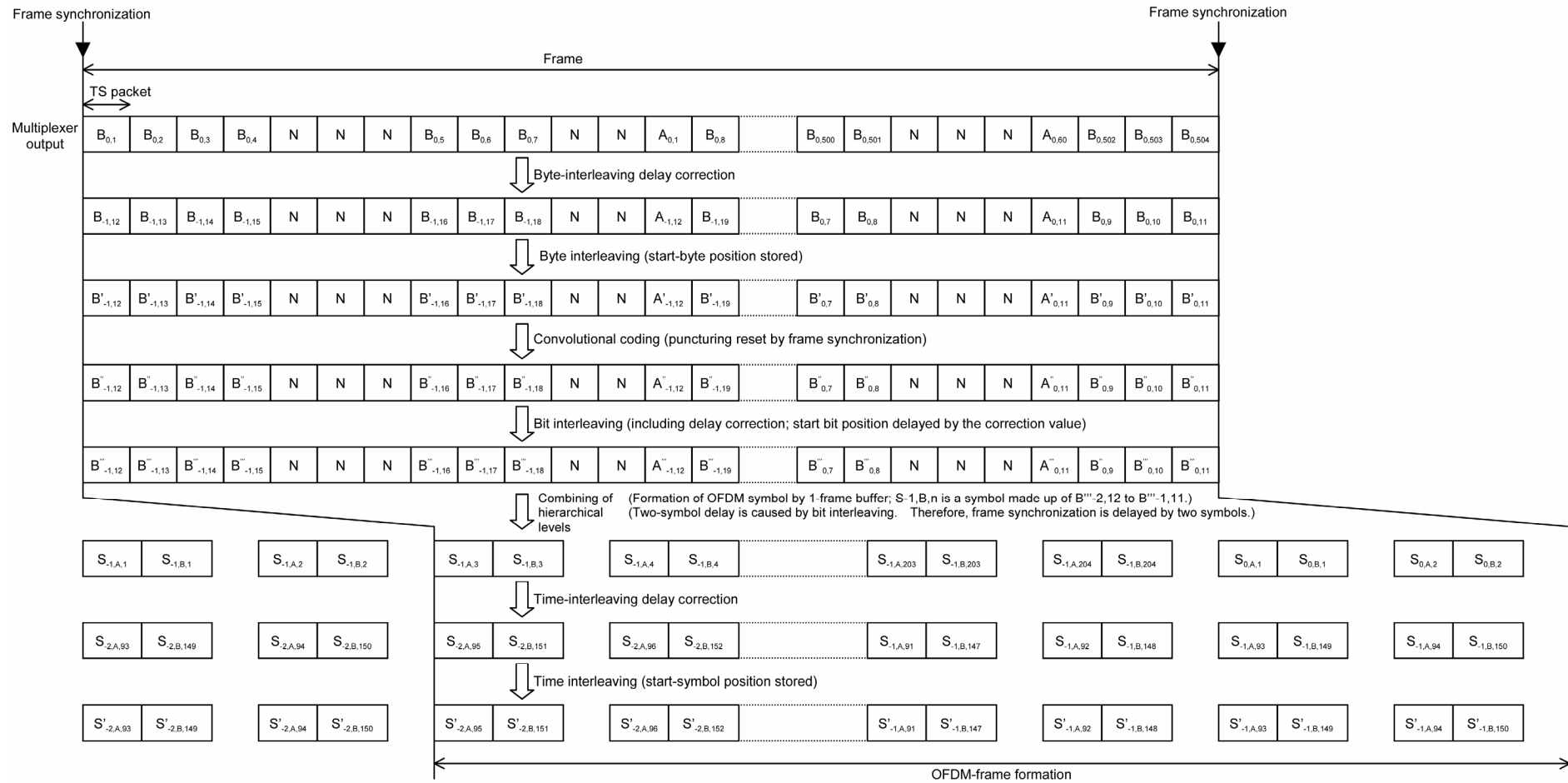

Fig. 3-7: Example 2 of a Signal Transmission System



$A_{n,m}$ : mth TSP of the nth frame of hierarchical level A    N: Null TSP     $S_{n,B,m}$ : mth OFDM symbol of the nth frame of hierarchical level B

(Hierarchical layer A: DQPSK, convolutional-coding rate of 1/2, 5 segments,  $l = 16$ )

(Hierarchical layer B: 64QAM, convolutional-coding rate of 7/8, 8 segments,  $l = 8$ )

Fig. 3-8: Time Interleaving and Delay Adjustment (Example of Processing on the Transmitting Side)

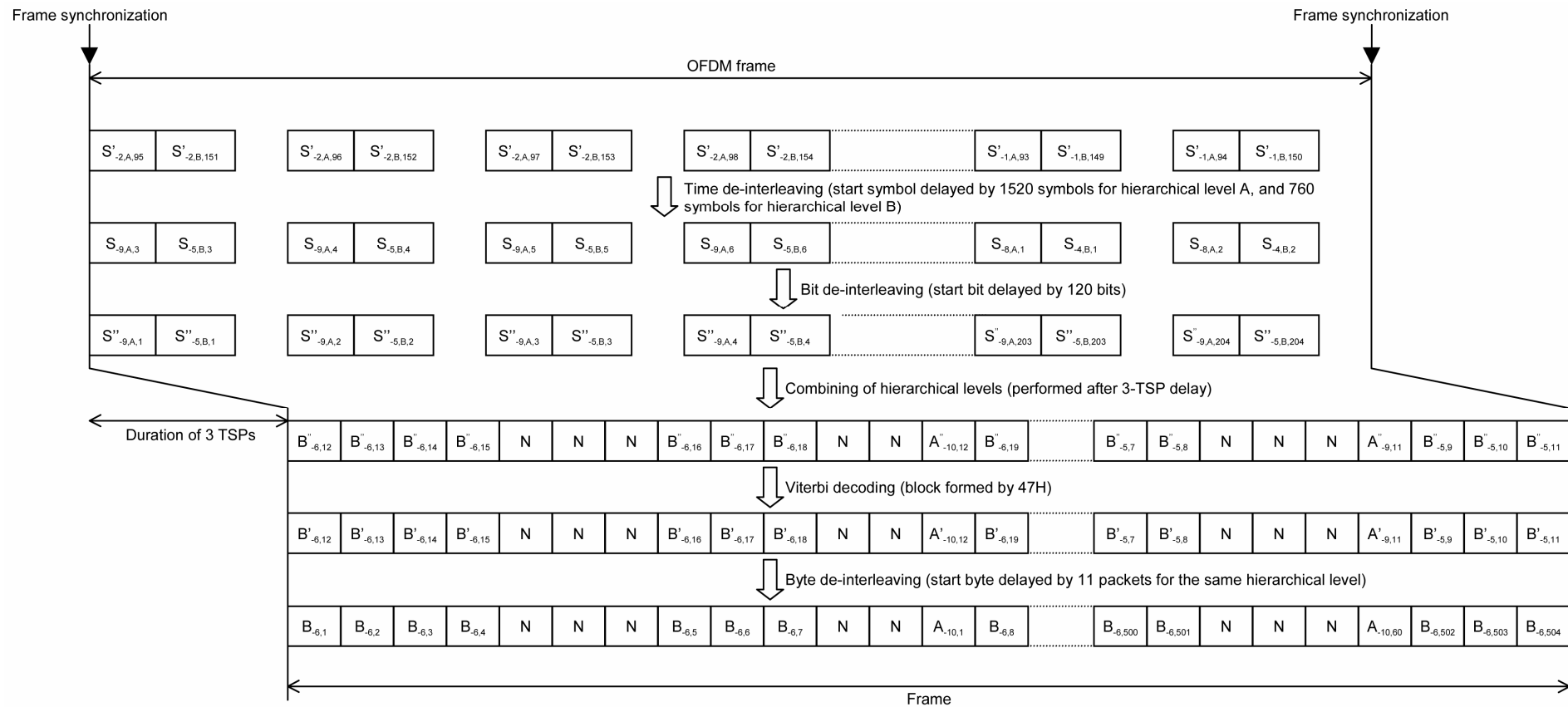

(Hierarchical layer A: DQPSK, convolutional-coding rate of 1/2, 5 segments, I = 16)

(Hierarchical layer B: 64QAM, convolutional-coding rate of 7/8, 8 segments, I = 8)

Fig. 3-9: Time Interleaving and Delay Adjustment (Example of Processing on the Receiving Side)

### 3.4 Video coding scheme

In the case of hierarchical transmission with multiple layers, it is possible to transmit services whose video coding scheme is conformed to the MPEG-2 Video (ITU-T Rec. H.262, ISO/IEC 13818-2) with the constraints shown below in addition to television services specified in the ARIB STD-B32 standard. Selection of each coding parameter should be made by the judgment of each broadcasting provider considering picture quality, required bit rate and reception quality, etc.

#### 3.4.1 Constraints of video coding parameter

Table 3-6 shows constraints of video coding parameter.

Table 3-6: Constraints of video coding parameter

Constraints of sequence_header				Constraints of sequence_extension	Constraints of sequence_display_extension			Other parameters
vertical_size_value	horizontal_size_value	aspect_ratio_information	frame_rate_code	progressive_sequence	color_primaries	transfer_characteristics	matrix_coefficients	
240	352	2, 3	4 <sup>(Note2)</sup>	1	1	1	1	Value specified for MP@LL
120 <sup>(Note1)</sup>	176							

(Note 1) In the MPEG-2 coding scheme, 128 lines are coded actually.

(Note 2) When transmittable bit rate is extremely low, encoding method that does not change the frame\_rate\_code and lowering the actual coded frame rate by using skipped macroblock, etc., is also effective.

#### 3.4.2 Constraints of still picture coding parameter

Table 3-7 shows constraints of coding parameter in still picture. One frame of still picture is coded as I frame and transmitted by surrounding it with sequence\_header\_code and sequence\_end\_code, as an independent sequence.

Table 3-7: Constraints of still picture coding parameter

Constraints of sequence_header				Constraints of sequence_extension		Constraints of sequence_display_extension			Other parameters (Note 5)
vertical_size_value	horizontal_size_value	aspect_ratio_information	frame_rate_code <sup>(Note 2)</sup>	progressive_sequence	low_delay	color_primaries	transfer_characteristics	matrix_coefficients	
1080 (Note 1)	1440, 1920	3	4	0 <sup>(Note 3)</sup>	1 <sup>(Note 4)</sup>	1	1	1	Value specified for MP@HL
480	720	3	7	1					Value specified for MP@H14L
		2, 3	4	0 <sup>(Note 3)</sup>					Value specified for MP@ML
240	352	2, 3	4	1					Value specified for MP@LL

(Note 1) In the MPEG-2 coding scheme, 1088 lines are coded actually.

(Note 2) Timing of decoding and display is controlled by time stamp value in the PES header, and the value of vbv\_delay should be 0xFFFF.

- (Note 3) In the case of progressive\_frame=0 (with timing difference due to interlaced scanning of the two fields in a frame), display of a freeze field is recommended and in the case of progressive\_frame=1 (same timing in the two fields in a frame) display of a freeze frame is recommended.
- (Note 4) In the case of low\_delay=1, time stamps of decoding and display are the same value (DTS=PTS). Only PTS is attached in the still picture coded as I frame.
- (Note 5) For values of vbv\_buffer\_size\_value, etc., values specified in ISO/IEC 13818-2 for each level of the Main Profile should be adopted. However, bti\_rate\_value should be the maximum value of each level and MP@LL should be 4Mbps, MP@ML should be 15Mbps, and values for MP@H14L and MP@HL should be the maximum capacity that can be transmitted by terrestrial digital broadcasting.

Table 3-8 shows meaning of each code number of the MPEG-2 coding parameter shown in Tables 3-6 and 3-7.

Table 3-8: Meaning of each code number of MPEG-2 coding parameter

aspect_ratio_information	2 = 4:3 display	3 = 16:9 display
frame_rate_code	4 = 30/1.001 Hz	7 = 60/1.001 Hz
progressive_sequence	0 = Interlaced	1 = Progressive
low_delay	1 = Not including B picture	
color_primaries	1 = Nominal value of Rec.ITU-R BT.709(BT.1361)	
transfer_characteristics	1 = Nominal value of Rec.ITU-R BT.709(BT.1361)	
matrix_coefficients	1 = Nominal value of Rec.ITU-R BT.709(BT.1361)	

## Chapter 4: Guidelines for Synchronization

### 4.1 Synchronization for SFN

To implement SFN, the following requirements must be met in order to establish synchronism between broadcast waves:

#### 4.1.1 Transmission frequency

To prevent interference between carriers within the SFN service area, the variations in the transmission frequency of each broadcast wave must be 1 Hz or less.

#### 4.1.2 IFFT sampling frequency

To implement SFN by means of OFDM signals generated by different IFFT sample clocks, as when multiple OFDM modulators are used, all IFFT sample-clock frequencies must be identical.

If one of the frequencies differs from the others, the difference affects the OFDM symbol period, that is, symbol speed. Consequently, a symbol shift beyond the guard interval length is produced between OFDM signals, causing interference between symbols.

Note also that the frequency of each of the uppermost and lowermost carriers of the frequency band must not vary any more than 1 Hz as a result of variations in the sample frequency.

#### 4.1.3 OFDM signals

When multiple OFDM modulators are used, the output OFDM-signal waveforms must be the same at all SFN stations.

Note that it is preferable to select a transmission timing such that the difference in delay time within the service area is shorter than the guard interval.

## Chapter 5: Signal Transmission Scheme to STL/TTL

This chapter specifies the signal format and synchronization establishment scheme to transmit the terrestrial digital television broadcast signal to STL.

The signal transmission method among broadcasting stations is also specified for the network configuration including SFN.

### 5.1 Types of interface point

Interface points are indicated in the figures as shown below.

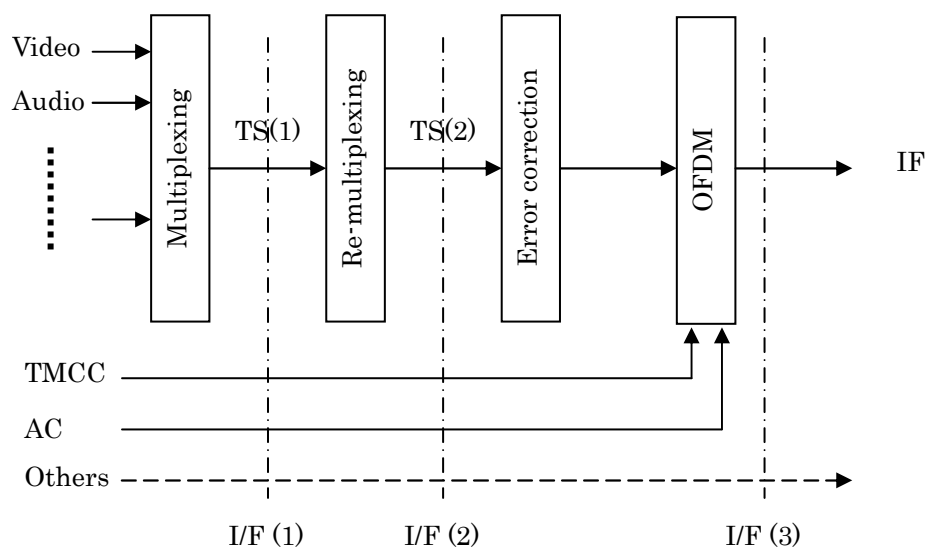

- TS (1) The TS signal in accordance with the MPEG-2 systems, which does not have the multiplexed frame construction of terrestrial digital television signal. Hereinafter referred to as usual TS.
- TS (2) The TS signal in accordance with the MPEG-2 systems, which has the multiplexed frame construction of terrestrial digital television signal. Hereinafter referred to as broadcasting TS. The signal after TS re-multiplexing is specified in Chapter 3 clause 3.2 in this document and having multiplexed frame construction.

Fig. 5-1: Types of interface point

## 5.2 Types of synchronization scheme

Among the interface points defined in clause 5.1, The signal format is TS signal in I/F (1) and I/F (2). Therefore, the IFFT sample frequency should be synchronized with the studio and the broadcasting station or among the broadcasting stations.

Table 5-1: Interface point and synchronizing scheme

Relay method	Interface point	Interface signal		Note
Broadcast wave relay	RF	OFDM signal	Unnecessary	
	I/F (3)		Only synchronization	RF
STL/TTL	I/F (2)	Broadcasting TS	Slave synchronization	
			Synchronization conversion	Quasi-synchronization equipment required
			Complete synchronization	Clock should be returned
			Reference synchronization	Usage of JJY, GPS, etc.
	I/F (1)	Usual TS	Slave synchronization	
			Synchronization conversion	Synchronization conversion by re-multiplex device.
Reference synchronization			Usage of JJY, GPS, etc.	

Synchronization method types are specified in this section.

### 5.2.1 Complete synchronization

Any of one modulator clock in either of the broadcasting stations should be used as a reference clock of network, and the clock of other broadcasting station or studio should synchronize to the reference clock. However, a separate link to transmit the clock should be prepared, in addition to the TS transmission link, to transmit the terrestrial digital television broadcasting signal.

### 5.2.2 Slave synchronization

The clock of modulator in each transmitting stations is synchronized to the clock of multiplexer or re-multiplexer in broadcasting studio .

For the studio clock transmission method, there is a method to synchronize with the bit clock of STL/TTL, etc.

### 5.2.3 Reference synchronization

This method synchronizes the studio and all the broadcasting stations by synchronizing with a signal other than the terrestrial digital television broadcasting network.

For the synchronizing signal, there are GPS and JJY, etc.

### 5.2.4 Synchronization conversion (Quasi-synchronization)

This synchronization conversion method is to write the received TS signal which is transmitted from the forward station or studio on the input buffer temporary, and read out this TS signal by the clock signal of following station, which is asynchronous to the forward station or studio.

A TS signal from the forward\_station is transmitted by inserting more than a specific null TSP, and this TSP signal can be inserted and deleted at the following station to obtain the synchronization conversion.

However, as up to three hierarchical layers can be transmitted as a layer transmission in the terrestrial digital television broadcasting, the synchronization conversion device is necessary in each layer, in the case of the layer transmission. But, the re-multiplexer written in Fig. 5-1 has a equivalent function of synchronaization conversion, therefore, in case of interface I/F(1), re-multiplexer can be substituted for synchronization conversion function.

In case of the SFN operation, the OFDM signals must be same at all SFN stations, but, in this method, transmitting signal may be changed by adding/deleting the null packets therefore, this method is not appropriate as a synchronizing method among the broadcasting stations for the SFN operation.

### 5.3 Assumed broadcasting network types

As specified in the Appendix Chapter 4 “Synchronization Operation Guideline,” the following conditions should be satisfied for SFN operation.

- (1) The RF frequency accuracy should be within 1Hz.
- (2) The IFFT sampling clock should coincide averagely and the frequency difference between each transmission-band edge carriers due to frequency drift of IFFT sample clock should be within  $\pm 0.3\text{ppm}$ .
- (3) The multiplexed frames should be the same. (The TS (2) in Fig. 5-1 should coincide.)
- (4) The delay time difference of the OFDM frame synchronization signal phase (including even number (W0), odd number (W1) frame synchronization signal phase) should be positioned within the guard interval period at the SFN interference area.

On the other hand, when the frequency differs from that of other broadcasting stations, or when the frequency is the same but the broadcasting area does not overlap geographically, (hereinafter, referred to as MFN) the condition should be as follows.

- (1) The RF frequency accuracy should be within 500Hz, provided the Minister of Public Management, Home Affairs, Posts and Telecommunications has agreed that it does not obstruct the effective radio wave usage excessively.
- (2) The frequency difference between transmission-band edge carriers due to the frequency drift of the IFFT sample clock should be within  $\pm 0.3\text{ppm}$ .
- (3) It is not necessary for the multiplexed frames to be identical.
- (4) The sending timing of the OFDM frame synchronization phase (including TMCC frame synchronization phase) does not have to be specified.  
For (3), it means that TS (2) do not necessarily have to be identical as long as the receiver unit can decode without contradiction.

As the required specification of the sending interface condition and synchronizing method differs according to whether the SFN is assumed or not in the broadcasting network, the broadcasting network is modeled depending on whether it is SFN or MFN.

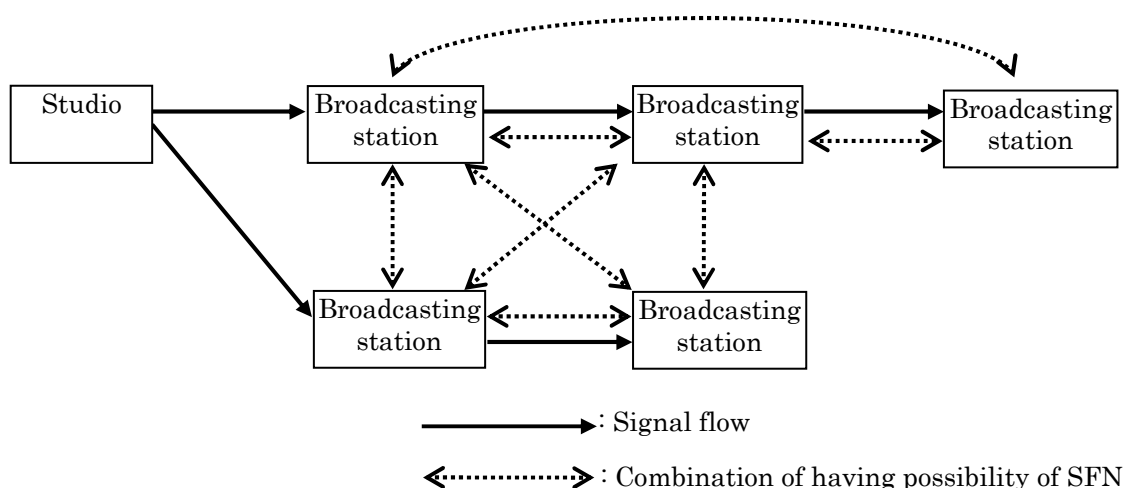

Fig. 5-2: Construction of broadcasting network and combination with SFN

### 5.3.1 Network construction without having to consider SFN conditions

(1) When transmitting signal from a studio to one broadcasting station.

(Case 1)

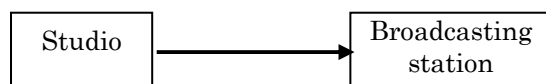

Fig. 5-3: When transmitting signal from a studio to one broadcasting station

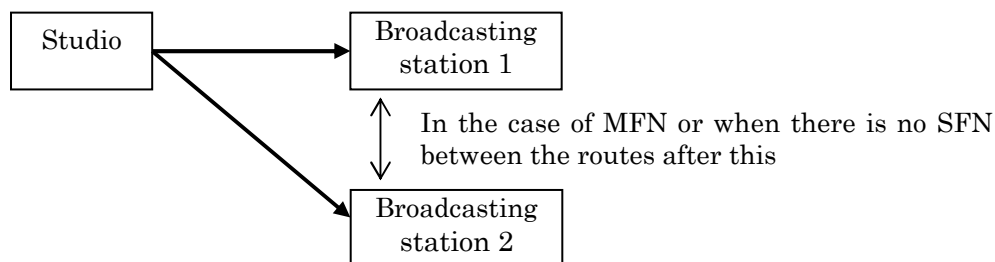

Fig. 5-4: When transmitting signal from a studio to plural broadcasting stations of MFN operation

(2) When the forward station and following station are in MFN operation and the entire route after the following station is MFN operation.

(Case 2)

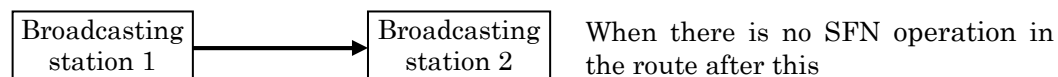

Fig. 5-5: When the entire route after the following station is MFN construction

### 5.3.2 Network operation necessary to consider the SFN condition

- (1) When transmitting the signal from a studio to multiple broadcasting stations of SFN ruction-operation.  
(Case 3)

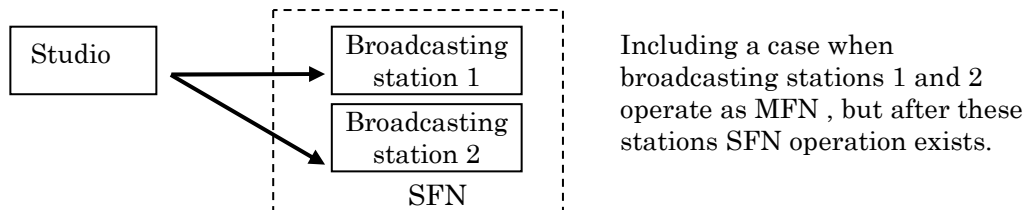

Fig. 5-6: When transmitting signal to a studio to plural broadcasting station of SFN operation

- (2) When forming the SFN construction between the forward\_station and following station  
(Case 4)

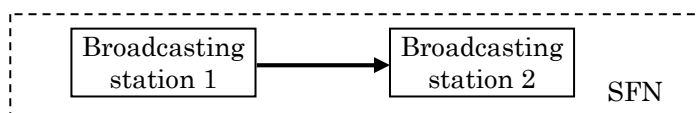
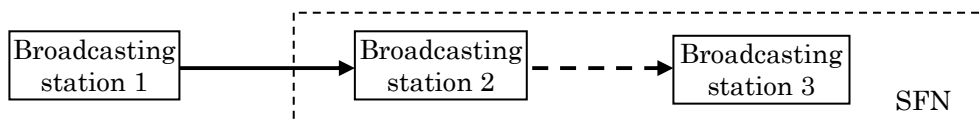

Fig. 5-7: When SFN construction is formed between the forward\_station and following station

- (3) When MFN construction is employed between the forward and following stations but SFN construction is employed in the route after the following station.  
(Case 5)



Cases when SFN construction is employed between the following station and the broadcasting stations in the other route are included.

Fig. 5-8: When SFN construction is employed in the routes after the following station

- (4) Cases when MFN construction is employed between the forward and following station but SFN construction is employed after both the forward and following stations.  
(Cases 6)

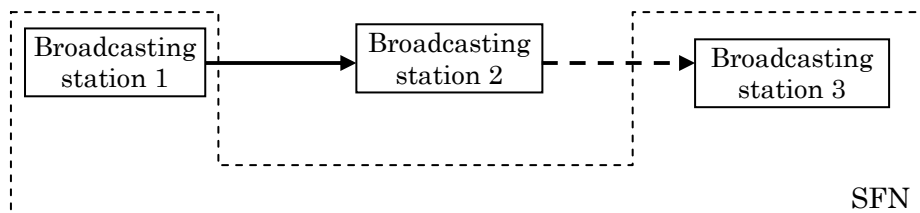

Fig. 5-9: When SFN construction is employed after both the forward and following stations

## 5.4 Usage examples of synchronization method considering SFN

For cases 3 to 6 in clause 5.3.2 in the network construction shown in clause 5.3, consideration of SFN condition for the synchronization method is necessary.

This clause discusses usage examples of synchronization method applicable to the network construction, in which consideration of SFN is necessary.

### 5.4.1 Interface point and synchronization method when considering SFN

Problems and conditions when considering SFN in the interface point and synchronization method shown in clause 5.2 are shown in Table 5-2.

Table 5-2: Interface point and synchronization method when considering SFN

No.	Interface point	Synchronization method	Problems and conditions when considering SFN
1	RF	Unnecessary	Delay time in the SFN area cannot be controlled
2	I/F (3)	Only RF synchronization	For the delay time control in the SFN area, the delay time of forward transmitting station is controlled by adding the fixed delay to compensate the time delay difference between forward station and following station which is caused by TTL transmission to following station. .
3	I/F (2)	Slave synchronization	Slave synchronization to the signal sent from forward station
4		Synchronization conversion	The synchronization conversion process may change the multiplexed frame construction.
5		Complete synchronization	Synchronization signal delivery method should be studied separately.
6		Reference synchronization	Entire network is synchronized by GPS and JJY, etc.
7	I/F (1)	Slave synchronization	Re-multiplexer should be equipped at the transmitting station, therefore, multiplexed frame construction may be changed. In addition above, a method to verify final output TS is required separately.
8		Synchronization conversion	
9		Reference synchronization	

As shown in the above table, I/F (1) can be applied to STL (signal delivery method to a main transmitting station, shown in clause 5.3.2 case 1 ) in which a loopback link is comparatively easy to secure, in the cases of MFN shown in clause 5.3.1. However, it is difficult to apply to network considering SFN.

It may be possible to apply the synchronization conversion in I/F (2) to STL, similar to the I/F(1), however, there is a problem in multiplexed frame coincidence, when considering the application to SFN. For complete synchronization, application to SFN is not practical as consideration of a synchronized signal distribution method is necessary.

### 5.4.2 Usage examples of synchronization method corresponding to the broadcasting network

For the network considering SFN as shown in clause 5.4.1, use of I/F (3) and RF broadcasting signal relay method are recommended in addition to the slave synchronization of I/F (2) and reference synchronization.

In this clause, usage examples of each synchronization method and important notice when applying to cases 3 to 6 of the broadcasting network construction shown in clause 5.3.2 are discussed.

Table 5-3: Example of the interface using I/F (2)

Synchronization system	Slave synchronization	Reference synchronization
Signal format	204 byte broadcasting TS format	204 byte broadcasting TS format
Example of network construction		
Application to SFN condition	RF frequency	<ul style="list-style-type: none"> <li>• Frequency difference should be within 1Hz in each broadcast station</li> </ul>
	IFFT sampling clock	<ul style="list-style-type: none"> <li>• Synchronization reproduction of STL/TTL signal from the studio or forward station</li> <li>• Care should be taken when using ATM line in place of STL/TTL of radio system</li> <li>• In the case of cascade link connection, care should be taken for the amount of jitter generated in synchronization reproduction.</li> </ul>
	Multiplexed frame	<ul style="list-style-type: none"> <li>• The signal discriminating the head of the OFDM frame is added (see clause 5.5).</li> </ul>

	Sending timing	<ul style="list-style-type: none"> <li>Adjust the transmitting timing to add the fixed delay in condition that the delay of the system is constant.</li> </ul>	<ul style="list-style-type: none"> <li>Relative delay from second pulse supplied from GPS and/or JJY is used for transmitting timing adjustment (see clause 5.5)</li> </ul>
--	----------------	--	---

Ⓜ : Master clock

Ⓢ : Slave clock

Table 5-4: Examples of the interface using I/F (3) and broadcasting signal relay method

Synchronization system	OFDM-IF interface		Broadcasting signal relay method	
Signal format	OFDM signal		OFDM signal	
Example of network construction				
Application to SFN condition	RF frequency	<ul style="list-style-type: none"> <li>Deviation should be within 1Hz in each broadcast station</li> </ul>	<ul style="list-style-type: none"> <li>Frequency difference should be within 1Hz in each transmitting station by using common local signal for both transmitting and receiving portion in broadcasting signal relay station.</li> </ul>	
	IFFT sampling clock	<ul style="list-style-type: none"> <li>Not applicable as it is OFDM transmission.</li> </ul>	<ul style="list-style-type: none"> <li>Not applicable as it is OFDM transmission.</li> </ul>	
	Multiplexed frame	<ul style="list-style-type: none"> <li>Not applicable as it is OFDM transmission.</li> </ul>	<ul style="list-style-type: none"> <li>Not applicable as it is OFDM transmission.</li> </ul>	
	Sending timing	<ul style="list-style-type: none"> <li>.Adjust the transmitting timing to add the fixed delay in condition that the delay of the system is constant.</li> </ul>	<ul style="list-style-type: none"> <li>Delay adjustment is impossible by receiving the broadcasting wave.</li> <li>It is desirable to apply this system not to occur the interference for considering the relationship between distance of stations and guard interval length</li> </ul>	

Interface examples when using each synchronization method are shown in Tables 5-3 and 5-4.

Network construction can be made by combining multiple synchronized methods among the 4 types of method shown in the table. Therefore, it is recommended to select an appropriate synchronization method according to each network condition.

## 5.5 Additional information necessary for re-multiplexing TS transmission

The transmitting control information should be provided when transmitting the re-multiplexing TS using I/F (2) in which the interface is TS having multiplexed frame construction, among the interface points shown in Fig. 5-1. The types and transmission method are discussed in this clause.

### 5.5.1 Types of additional information

There are the following two types of multiple positions when multiplexing the transmitting control information to the broadcast TS.

- (1) Multiplexed to the dummy byte part of each TSP (Transport Stream Packet)
- (2) Multiplexed as invalid hierarchical TSP (such as IIP, ISDB-T Information Packet).

Transmission is made as shown below, according to the transmission items of the transmitting control information.

Table 5-5: Transmission items of the transmitting control information and multiplex position

No.	Transmission item	Description	Multiplex position	
			Dummy byte	Invalid hierarchy
1	TMCC ID	00: BS digital 10: Terrestrial digital TV 11: Terrestrial digital audio	○	
2	Buffer reset flag	Synchronization device buffer reset control	○	
3	Starting control for emergency-alarm broadcasting	Designating the duration of emergency-alarm broadcast execution	○	○
4	TMCC change top packet flag	Designation of top packet to change	○	
5	Frame top packet flag	Designation of top packet of multiplexed frame	○	
6	Frame synchronization designation (w0,w1)	Designation of duration of even number or odd number frames	○	○
7	Hierarchy information of each TSP	Hierarchy discrimination of A, B, C, NULL Designation of TSP that carries IIP or that carries AC data	○	
8	Transmission parameter switching index		○	○
9	TSP counter	Multiplexed frame top packet is 0. Incremented in the order of packet.	○	
10	TMCC (including mode and GI)	TMCC and modulation device control information		○
11	Broadcasting network control information	Control information such as delay at SFN		Optional
12	AC data	Information transmitted by AC	Optional	Optional

However, for items overlapping both dummy byte and invalid hierarchy, it should be multiplexed so as not to contradict each other.

Detailed information on AC data is described in Chapter 6 in this Appendix .

## 5.5.2 Multiplex to dummy byte part

### (1) Multiplex position

Interface signal format should be re-multiplexing TS format having multiplexed frame construction of 204 byte and should be multiplexed on 8 byte other than information part of 188 byte, and information shown in Table 5-5 should be multiplexed.

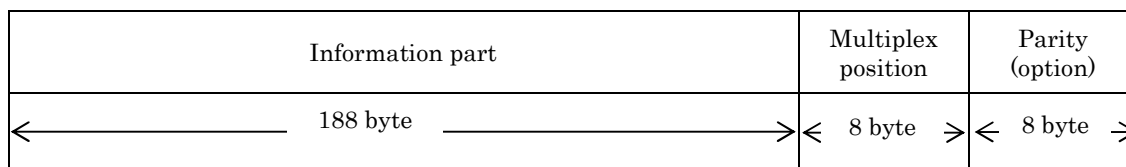

Fig. 5-10: Multiplex position on dummy byte

Additional information multiplexed on the above dummy byte indicates the information of the TSP. The multiplexed additional information is called ISDB-T\_information.

It should be possible to add the following parity when required.

The parity should apply the shortened Reed-Solomon code (204,196) generated by adding 00HEX of 51 byte in front of the input data byte in the case of (255,247) Reed-Solomon code and deleting the top 51 byte.

As for the original (255, 247) Reed-Solomon code, original of GF(28) and the primitive polynomial defining GF(28) are as follows:

$$p(x) = x^8 + x^4 + x^3 + x^2 + 1$$

For generator polynomial:

$$g(x) = (x - \lambda^0) (x - \lambda^1) (x - \lambda^2) (x - \lambda^3) (x - \lambda^4) (x - \lambda^5) (x - \lambda^6) (x - \lambda^7),$$

where,  $\lambda = 02_{HEX}$

(2) Multiple information

Table 5-6: Syntax of ISDB-T\_information

Data Structure	Number of Bits	Bit String Notation
ISDB-T_information(){ TMCC_identifier reserved buffer_reset_control_flag switch-on_control_flag_for_emergency_broadcasting initialization_timing_head_packet_flag frame_head_packet_flag frame_indicator layer_indicator count_down_index AC_data_invalid_flag AC_data_effective_bytes TSP_counter if(AC_data_invalid_flag==1) stuffing_bit else{ AC_data } }	2 1 1 1 1 1 1 4 4 1 2 13 32 32	bslbf bslbf bslbf bslbf bslbf bslbf bslbf bslbf bslbf bslbf bslbf bslbf bslbf bslbf

Table 5-7: Description of ISDB-T\_information syntax (bit0 = LSB)

Byte	bit	Syntax	Description
0	7	TMCC identifier	Discrimination of terrestrial digital TV
	6	(TMCC discrimination)	
	5	Reserved	To be '1'
	4	buffer_reset_control_flag (Buffer reset flag)	Synchronized device buffer reset control signal In case of buffer reset, '1' Normally, '0'
	3	switch-on_control_flag_for_ emergency_broadcasting (Start control for emergency-alarm broadcasting)	Receiver unit start control signal in case of emergency broadcasting. During emergency broadcasting, '1' Normally, '0'
	2	initialization_timing_head_packet_flag (Changing designation)	The changed head packet is '1'. Normally, it is '1'. (The transmission parameter switching index is counted down and when it returned to '1111,' the head packet of the frame is '1.'
	1	frame_head_packet_flag (Frame head flag)	Discriminates the head of multiple frames. The multiple frame head packet is '1' regardless of even number or odd number frames. Others are '0.'
	0	frame_indicator (Frame synchronization discrimination)	During even frame (W0) of the OFDM frame, it is '0.' During odd frame (W1) of the OFDM frame, it is '1.'
1	7-4	layer_indicator (Hierarchy information for each TSP)	Indicates the hierarchy by which the TSP is transmitted. '0000': A null-TSP which is not transmitted by any of hierarchy A, B, or C. '0001': TSP transmitted by hierarchy A. '0010': TSP transmitted by hierarchy B '0011': TSP transmitted by hierarchy C '0100': TSP which transmits AC data but not transmitted by any of hierarchy A, B, or C '0101'~'0111': TSP that service providers multiplex the original data '1000': TSP which transmits the IIP but not transmitted by any of hierarchy A, B, or C. '1001'~'1111': TSP that service providers multiplex the original data
	3-0	count_down_index (Transmission parameter switching index)	Transmission parameter switching index described in the TMCC information.
2	7	AC_data_invalid_flag (AC data flag multiplexed on the dummy byte part)	When AC data is not added to the dummy byte part: '1' When AC data is added to the dummy byte part: '0'
	6-5	AC_data_effective_bytes (Actual number of AC data bytes to be transmitted by broadcasting waves)	'00': 1-byte '01': 2-byte '10': 3-byte '11': 4-byte (including the case in which AC data is not added to the dummy byte part) Among bytes 4 to 7, the byte position to be used should be specified by each service provider.
	4-0	TSP_counter (TSP counter)	A counter in which the head packet of the multiplex frame is 0 and increments one by one in the order of packet.
3	7-0		Increments including NULL-TSP, TSP that transmits IIP or AC data, etc.

4	7-0	AC_data (AC data)	Area for AC data (Is not transmitted in the case of AC_data_invalid_flag =‘1’)
5	7-0	AC_data (AC data)	
6	7-0	AC_data (AC data)	
7	7-0	AC_data (AC data)	

### 5.5.3 Multiplex to invalid hierarchy IIP (ISDB-T\_Information\_Packet)

(1) Multiplex position

The IIP is inserted in the 188th byte of the packet information part in which the layer\_indicator in Table 5-7 becomes ‘1000,’ and only one packet is multiplexed in the multiplex frame.

Information indicated by IIP indicates the information of next multiplex frame.

(2) IIP information

Table 5-8: Syntax of IIP (ISDB-T\_Information\_Packet)

Data Structure	Number of Bits	Bit String Notation
ISDB-T_information_packet(){		
TSP_header{		
sync_byte	8	bslbf
transport_error_indicator	1	bslbf
payload_unit_start_indicator	1	bslbf
transport_priority	1	bslbf
PID	13	uimsbf
transport_scrambling_control	2	bslbf
adaptation_field_control	2	bslbf
continuity_counter	4	uimsbf
}		
payload{		
IIP_packet_pointer	16	uimsbf
modulation_control_configuration_information()	160	bslbf
IIP_branch_number	8	uimsbf
last_IIP_branch_number	8	uimsbf
network_synchronization_information_length	8	uimsbf
network_synchronization_information()		
for(i=0;i<(159- network_synchronization_information_length);i++){		
stuffing_byte(0xFF)	8	bslbf
}		
}		
}		

Table 5-9: Description of the syntax of IIP

Syntax	Description
sync_byte	TSP synchronization byte. 0x47('0100 0111')
transport_error_indicator	Not used. Should be always '0'
Payload_unit_start_indicator	Should be always '1'
transport_priority	Not used. Should be always '0'
PID	Should be service provider defined. However, the same PID is used for terrestrial digital television broadcasting.
transport_scrambling_control	Not used. Should be always '00'
adaptation_field_control	Should be always '01' (only payload)
continuity_counter	Should be used in accordance with ISO/IEC13818-1.
IIP_packet_pointer	Indicates the number of packet from the multiplex position to the next multiplex frame head in the multiplex frame of the ISDB-T_Information_Packet. The value of the last TPS of the multiplex frame should be 0 and should be counted from the multiplex position of the ISDB-T_Information_Packet to the next multiplex frame head in TSP unit.
IIP_branch_number	Indicates the branch number of the IIP. When the network_synchronization_information is not within 159 byte, the network_synchronization_information can be overlapped on multiple packets (sub IIP packet). This branch number (sub IIP packet) goes round for each IIP packet. The IIP_branch_number of the first packet in the sub IIP packet is 0x00.
last_IIP_branch_number	Indicates the last IIP_branch_number of the sub IIP packet. When the sub IIP packet is constructed by only one packet (when the network_synchronization_information is within 159 byte), 0x00 is indicated and when the sub IIP packet is constructed by two packets, 0x01 is indicated.
network_synchronization_information_length	Length of the following network_synchronization_information is designated. The value of this length should be 159 or less.

As the IIP packet should be one TSP per multiplex frame, the payload is 184 bytes. For transmitting information exceeding 184 bytes, it should be transmitted by overlapping on multiple multiplex frames.

When the IIP is constructed by multiple TSPs, the TSP inserted in the multiplex frame is called the sub IIP packet.

The relation between IIP\_branch\_number and last\_IIP\_branch\_number, when the sub IIP is constructed by two packets, is shown below.

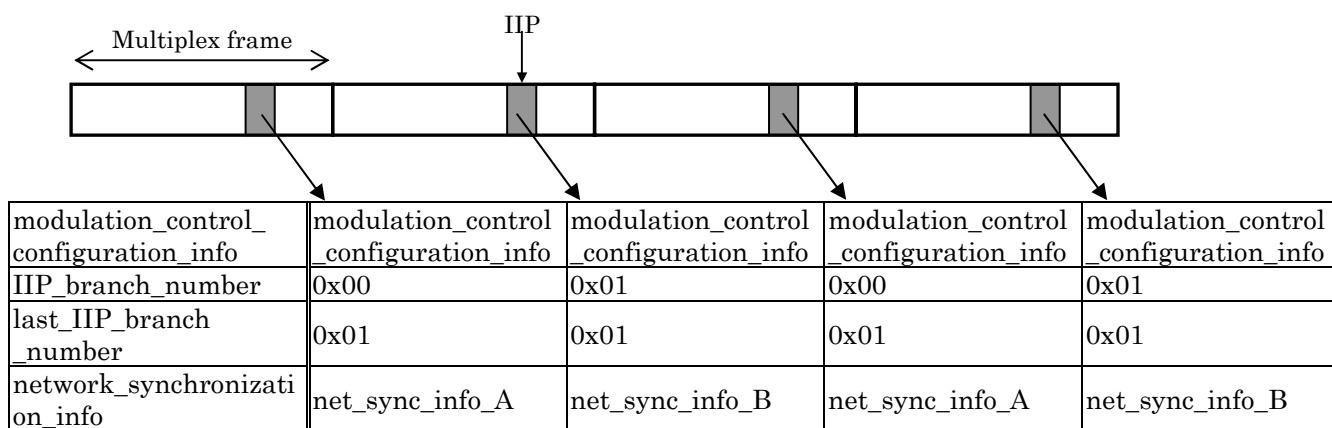

Note 1: Unless the contents of modulation\_control\_configuration\_information is changed, the same content is maintained, not in accordance with the IIP\_branch\_number.

Note 2: For net\_sync\_info\_A / B, different contents of the equipment loop (mentioned later) goes round.

Fig. 5-11: Configuration example of sub IIP

(3) Configuration of modulation\_control\_configuration\_information

Table 5-10: Syntax of modulation\_control\_configuration\_information

Data Configuration	Number of Bits	Bit String Notation
modulation_control_configuration_information(){		
TMCC_synchronization_word	1	bslbf
AC_data_effective_position	1	bslbf
reserved	2	bslbf
mode_GI_information{		
initialization_timing_indicator	4	bslbf
current_mode	2	bslbf
current_guard_interval	2	bslbf
next_mode	2	bslbf
next_guard_interval	2	bslbf
}		
TMCC_information{		
system_identifier	2	bslbf
count_down_Index	4	bslbf
switch-on_control_flag_used_for_alert_broadcasting	1	bslbf
current_configuration_information{		
partial_reception_flag	1	bslbf
transmission_parameters_for_layer_A{		
modulation_scheme	3	bslbf
coding_rate_of_inner_code	3	bslbf
length_of_time_interleaving	3	bslbf
number_of_segments	4	bslbf
}		
transmission_parameters_for_layer_B{		
modulation_scheme	3	bslbf
coding_rate_of_inner_code	3	bslbf
length_of_time_interleaving	3	bslbf
number_of_segments	4	bslbf
}		
transmission_parameters_for_layer_C{		
modulation_scheme	3	bslbf
coding_rate_of_inner_code	3	bslbf
length_of_time_interleaving	3	bslbf
number_of_segments	4	bslbf
}		
}		
}		
next_configuration_information{		
partial_reception_flag	1	bslbf
transmission_parameters_for_layer_A{		
modulation_scheme	3	bslbf
coding_rate_of_inner_code	3	bslbf
length_of_time_interleaving	3	bslbf
number_of_segments	4	bslbf
}		
transmission_parameters_for_layer_B{		
modulation_scheme	3	bslbf
coding_rate_of_inner_code	3	bslbf
length_of_time_interleaving	3	bslbf
number_of_segments	4	bslbf
}		

<pre>         }         transmission_parameters_for_layer_C{             modulation_scheme             coding_rate_of_inner_code             length_of_time_interleaving             number_of_segments         }     }     phase_correctiton_of_CP_in_connected_transmission     TMCC_reserved_future_use     reserved_future_use } CRC_32 } </pre>	<pre>         3         3         3         4         3         12         10         32 </pre>	<pre>         bslbf         bslbf         bslbf         bslbf         bslbf         bslbf         bslbf         rpchof </pre>
--	---	---

Table 5-11: Description of syntax of modulation\_control\_configuration\_information

Syntax	Description
TMCC_synchronization_word	Synchronizes to the OFDM frame synchronization signal allocated in B1 to B16 of the TMCC carrier and transfers as follows. w0 (0011010111101110) = '0' w1 (1100101000010001) = '1'
AC_data_effective_position	Indicates whether invalid hierarchical data or dummy byte data is used as the actual AC data to be transmitted by broadcasting waves. '0': invalid hierarchical data is used '1': dummy byte data is used (including the case in which AC data is not multiplexed)
mode_GI_information	Information of transmission mode and guard interval ratio
initialization_timing_indicator	Indicates the switching timing of mode and guard_interval. <ul style="list-style-type: none"> <li>Normal value is 15('1111'). The value is decremented by OFDM frame unit from 15 frames before the switching timing.</li> <li>The switching timing should be the start timing of the first OFDM frame when the initial setting pointer value returns from 0 to 15.</li> </ul> During count down (when the value is other than 15), a revision of next_mode and next_guard_interval cannot be made.
Current_mode	Indicates the Mode (1,2,3) now being used '00': reserved '01': Mode 1    '10': Mode 2    '11': Mode 3
Current_guard_interval	Indicates the guard interval ratio now being used. '00': 1/32    '01': 1/16    '10': 1/8    '11': 1/4
next_mode	Indicates the next Mode
next_guard_interval	Indicates the next guard interval
TMCC_information	Same as the TMCC information in ISDB-T.
System_identifier	Same as the system discrimination in TMCC information.
count_down_index	Same as the transmission parameter switching index described in the TMCC information.
switch-on_control_flag_used_for_alert_broadcasting	Same as the start flag for emergency-alarm broadcasting described in the TMCC information.
current_configuration_information	Same as the current information of the TMCC information.
partial_reception_flag	Same as the conditional access flag described in the TMCC information.
transmission_parameters_for_layer_A	Same as the transmission-parameter information for hierarchical layer A of the TMCC information.
modulation_scheme	Same as the carrier modulation described in the TMCC information.
coding_rate_of_inner_code	Same as the convolution coding ratio described in the TMCC information.
length_of_time_interleaving	Same as time interleave length described in the TMCC information.
Number_of_segments	Same as the segment number described in the TMCC information.

transmission_parameters_for_layer_B	Same as the transmission parameter information for hierarchical layer B in the TMCC information.
transmission_parameters_for_layer_C	Same as the transmission parameter information for hierarchical layer C in the TMCC information.
next_configuration_information	Same as the next information of the TMCC information.
phase_correction_of_CP_in_connected_transmission	Same as the phase-shift-correction value for connected segment transmission described in the TMCC information.
TMCC_reserved_future_use	Same as the reserved bit (B110 to B121) described in the TMCC information
reserved_future_use	Reserved bit for future extension. All of them should be '1'.
CRC_32	CRC value calculated by the following polynomial used in ISO/IEC13818-1. Ranges are to all the modulation_control_configuration_information from TMCC_synchronization_word to future_use_bit. Polynomial= $x^{32} + x^{26} + x^{23} + x^{22} + x^{16} + x^{12} + x^{11} + x^{10} + x^8 + x^7 + x^5 + x^4 + x^2 + x + 1$

(4) Structure of network\_synchronization\_information

Table 5-12: Syntax of network\_synchronization\_information

Data Structure	Number of Bits	Bit String Notation
network_synchronization_information(){ synchronization_id if(synchronization_id==0x00){ SFN_synchronization_information{ SFN_synchronization_information_header{ synchronization_time_stamp maximum_delay } equipment_loop_length for(i=0;i<equipment_loop_length/5;i++){ equipment_control_information{ equipment_id renewal_flag static_delay_flag reserved_future_use time_offset_polarity Time_offset } } } } CRC_32 } else if(synchronization_id==0xFF){ for(j=0;j<N;j++){ stuffing_byte(0xFF) } } }	8  24 24  8  12 1 1 1 1 24  32  8	uimsbf  bslbf bslbf  uimsbf  uimsbf bslbf bslbf bslbf bslbf bslbf  rpchof  bslbf

Table 5-13: Description of syntax of network\_synchronization\_information

Syntax	Description
Synchronization_id	0x00 :SFN_synchronization_information is added 0x01~0xFE : For future extension 0xFF : SFN_synchronizaion_information is not added.
SFN_synchronization_information	Synchronization control information including delay time control in SFN network.
synchronization_time_stamp	Time difference from the reference time. Indicated in 10MHz periodic unit (on the 100ns time scale). Indicates the delay time of the head of the multiplex frame (start time) in which the next tmcc_synchronization_word is '0' against the latest 1pps signal gained from the time reference such as GPS, at the delivery output (Ex: output to STL) of the line to the broadcasting station.
maximum_delay	Maximum delay time. The time interval between the delivery output (Ex: output to STL) of the line to the broadcasting station at the studio and the broadcasting wave emission from the transmission antenna of each broadcasting station in the SFN network* <sup>Note 1</sup> . Indicated in 10MHz periodic unit (on the 100 ns time scale). This value should be set to less than 1 second [within the range between 0 (0x000000) and 9999999 (0x98967F)].
equipment_loop_length	Indicates the following entire length of equipment_loop. Indicates in byte units.
equipment_control_information	Information to control the offset of delay time or fixed delay time individually for each broadcasting station.
equipment_id	Designates each broadcasting station to control by the equipment_control_information.
renewal_flag	Renewal flag. When renewing the values of static_delay_flag, time_offset_polarity, and time_offset, this field in equipment_control_information of the targeted equipment_id will be renewed. When renewing the value of maximum_delay, this field in all equipment_control_information syntaxes (all equipment loops) will be renewed. This field toggles between '1' and '0' for renewal.
static_delay_flag	Static delay flag. For the delay control of SFN, the delay time may be adjusted by the reference time such as GPS in one case and typical and static delay time may be allocated to the broadcasting station not using the reference time in another case. The static delay flag should be '1' when the latter control is employed. In this case, the control information only time_offset is effective and only this value is used for delay control.
reserved_future_use	Reserved bit for future extension. The value should be '1'.
time_offset_polarity	Indicates polarity of the following time_offset. '0' should be designated for a positive value and '1' for a negative value. When static_delay_flag is '1', '0' should be always designated.

time_offset	<p>Indicated in 10-MHz periodic unit (on the 100 ns time scale). The meaning of this field changes according to the value of static_delay_flag:</p> <p>[When static_delay_flag = '0'] Indicates the offset of delay time at each broadcasting station against maximum_delay*<sup>Note1</sup>. This value, together with the polarity given by time_offset_polarity, is specified within the range of -1 second &lt; time_offset &lt; 1 second (between 0 (0x000000) and 9999999 (0x98967F) as the input value for this field).</p> <p>[When static_delay_flag = '1'] Indicates delay time, when setting a specific, fixed, delay time to a broadcasting station without using standard time *<sup>Note1</sup>. This value, which is less than 1 second, is specified within the range between 0 (0x000000) and 9999999 (0x98967F).</p>
CRC_32	<p>The CRC value is calculated by the following polynomial used in ISO/IEC13818-1.</p> <p>Ranges to all the SFN_synchronization_information from the (synchronization_time_stamp) which is the head of SFN_synchronization_information_header to time_offset.</p> <p>Polynomial=<math>x^{32} + x^{26} + x^{23} + x^{22} + x^{16} + x^{12} + x^{11} + x^{10} + x^8 + x^7 + x^5 + x^4 + x^2 + x + 1</math></p>

\* Note 1: The following time values indicated in the corresponding fields shall include the OFDM modulation time excluding the theoretical delay time due to time interleaving:

- the time interval between the delivery output of the line to the broadcasting station at the studio and the broadcasting wave emission from the transmission antenna of each broadcasting station in the SFN network (maximum\_delay);
- the value of maximum\_delay with the offset of delay time at each broadcasting station (maximum\_delay ± time\_offset) when static\_delay\_flag = "0" ;  
["+ " or "- " when time\_offset\_polarity is "0" or "1", respectively]
- the fixed delay time of each broadcasting station (time\_offset) when static\_delay\_flag = "1", .

Thus, the delay time required for SFN synchronization at each broadcasting station (the time between arrival at the broadcasting station and input to the modulator) needs to be calculated by deducting the time required for OFDM modulation (excluding the theoretical delay time due to time interleaving).

## Chapter 6: Operational guidelines for AC data transmission

This chapter defines multiplexing of AC data on broadcasting TS, timing of AC data multiplexed on broadcasting TS in relation to OFDM frames, and mapping of AC data to OFDM carriers. There are two types of multiplex positions when multiplexing AC data on broadcasting TS signals:

- (1) multiplexed on the dummy byte part of each TSP (Transport Stream Packet);
- (2) multiplexed on invalid hierarchy TSP.

### 6.1 Determination of broadcasting TS multiplex positions

Whether AC data is multiplexed on the dummy byte part or invalid hierarchy TSP is determined by looking at `AC_data_effective_position` of IIP's "modulation\_control\_configuration\_information". For more information, refer to Tables 5-10 and 5-11 in (3) of Section 5.5.3 in this Attachment.

### 6.2 Multiplexing on dummy byte part

#### 6.2.1 Multiplex position

When multiplexing AC data on the dummy byte part, the data should be multiplexed on the 8-byte part other than the 188-byte information part in the 204-byte broadcasting TS format. For more information, refer to Fig. 5-10 in (1) of Section 5.5.2 in this Attachment.

#### 6.2.2 Syntax for multiplexing AC data on dummy byte part

Multiplexing of AC data on the dummy byte part of TSP is defined by the syntax of `ISDB-T_information`. For more information, refer to Tables 5-6 and 5-7 in (2) of Section 5.5.2 in this Attachment.

#### 6.2.3 Mapping of AC data to OFDM carriers

This section defines the mapping of AC data to OFDM carriers; the AC data to be transferred as broadcasting TS. The AC data may be multiplexed on the dummy byte part or the invalid hierarchy of broadcasting TS. Multiplexing on the dummy byte part has an advantage of transmission with small delay.

##### 6.2.3.1 Timing of multiplexing AC data in relation to OFDM frames

AC data multiplexed on the dummy byte part is transmitted in synchronization with the OFDM frame pulse that immediately follows. Fig. 6-1 shows the transmission frame timing of AC data multiplexed on the dummy byte part. The AC data `AC#N` multiplexed on the multiplex frame `#N` is transmitted in synchronization with the OFDM frame pulse that immediately follows.

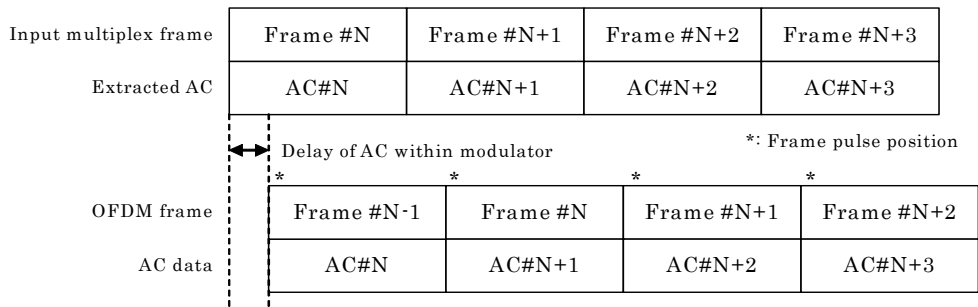

Note: Indicates the case where the delay of signal processing in the main line system within the modulator is one frame plus  $\alpha$  fraction.

Fig. 6-1 Illustrated timing of mapping to the dummy byte part

### 6.2.3.2 Order of mapping to OFDM carriers

Among the AC data multiplexed on the dummy byte part of TSP with `AC_data_invalid_flag = "0"`, the effective byte part indicated by `AC_data_effective_bytes` is considered as effective AC data. The positions of bytes to be used shall be specified by each service provider.

The effective data is mapped sequentially from lower- to higher-frequency AC carrier positions of OFDM. The MSB side of the effective byte part represents the head of the effective data. When mapping of data to all AC carriers of one symbol is finished, mapping advances to the next symbol. "Symbols" in this chapter means "OFDM symbols". Fig. 6-2 shows the order of mapping to the AC carrier positions of OFDM.

When there are differential OFDM segments, multiplexed AC data is mapped sequentially, regardless of AC1 or AC2, to AC carriers in the order of lower to higher frequencies.

Since the first OFDM frame symbol (symbol 0) is the reference for differential modulation for AC carriers, AC data is not mapped to this symbol. Within one multiplex frame, therefore, the amount of AC data mapped to AC carriers (including stuffed data if required) corresponds to 203 symbols.

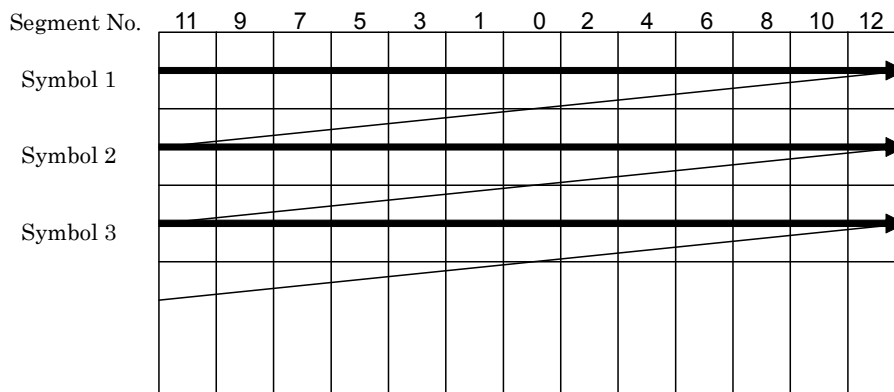

Fig. 6-2 Order of mapping to the AC carrier positions of OFDM

## 6.3 Multiplexing on invalid hierarchy

### 6.3.1 Multiplex position

When multiplexing AC data on the invalid hierarchy, the data is put into the 188-byte information part of the packet, where layer\_indicator described in Table 5-7 in (2) of Section 5.5.2 in this Attachment is "0100".

### 6.3.2 Syntax for multiplexing AC data on invalid hierarchy

The syntax for multiplexing AC data on the invalid hierarchy is listed and explained in Tables 6-1 and 6-2, respectively.

Table 6-1 Syntax for multiplexing AC data on the invalid hierarchy

Data Structure	Number of bits	Bit String Notation
<pre> AC_data_packet(){   TSP_header{     sync_byte     transport_error_indicator     payload_unit_start_indicator     transport_priority     PID     transport_scrambling_control     adaptation_flag_control     continuity_counter   }   payload{     AC_select_id     reserved_future_use     AC_packet_number     data_length     For(i=0;i&lt;data_length-4;i++){       AC_data     }     CRC_32     for(j=0;j&lt;180-data_length;j++){       stuffing_byte(0xFF)     }   } } </pre>	<p>8</p> <p>1</p> <p>1</p> <p>1</p> <p>13</p> <p>2</p> <p>2</p> <p>4</p> <p>4</p> <p>4</p> <p>16</p> <p>8</p> <p>8</p> <p>32</p> <p>8</p>	<p>bslbf</p> <p>bslbf</p> <p>bslbf</p> <p>bslbf</p> <p>unimsbf</p> <p>bslbf</p> <p>bslbf</p> <p>unimsbf</p> <p>unimsbf</p> <p>bslbf</p> <p>unimsbf</p> <p>unimsbf</p> <p>bslbf</p> <p>rpchof</p> <p>unimsbf</p>

Table 6-2 Description of syntax for multiplexing AC data on the invalid hierarchy

Syntax	Description
sync_byte	Synchronization byte (0x47)
transport_error_indicator	Not used (always "0")
payload_unit_start_indicator	Should be always "1" when there is one packet within one multiplex frame where AC data is multiplexed. When there are multiple packets, the first packet where AC data is multiplexed is given a value of "1" and all the subsequent packets are given a value of "0".
transport_priority	Should be always "0".
PID	Depends on the operational provisions of each service provider.
transport_scrambling_control	Not used (always "00")
adaptation_flag_control	Should be always "01" (only payload).
continuity_counter	Should be in accordance with ISO/IEC13818-1.
AC_select_id	When AC data is multiplexed and transmitted separately to different pieces of transmission equipment, this information allows selection of AC data that is relevant to each piece of equipment. This information is specified by service providers.
reserved_future_use	Reserved bits for future extension. All of them should be "1".
AC_packet_number	Numbers assigned to packets where AC data is multiplexed. These numbers are assigned sequentially from the first multiplex frame. AC_packet_number = "0x0000" for the first packet where AC data is multiplexed in the multiplex frame. Sequential numbers are given independently to each AC_select_id.
data_length	The length of data between the next byte of this syntax and CRC_32; specified in bytes.
AC_data	Multiplexed AC data. AC data is multiplexed as one or more bytes for each packet. When a fraction of byte occurs in the last packet of the multiplex frame where AC data is multiplexed, the remaining bits of the byte are stuffed by inserting "1" (See Section 6.3.3 "Data arrangement on multiplex frames and TS packets").
CRC_32	The CRC value calculated from the following polynomial used in ISO/IEC13818-1: $x^{32} + x^{26} + x^{23} + x^{22} + x^{16} + x^{12} + x^{11} + x^{10} + x^8 + x^7 + x^5 + x^4 + x^2 + x + 1$ . The range covers entirely from the beginning to the end of AC_data.

### 6.3.3 Data arrangement on multiplex frames and TS packets

Data on multiplex frames and TS packets is arranged as follows:

- (1) AC data multiplexed on one multiplex frame is multiplexed on the AC carriers of one OFDM frame.
- (2) The number of bits in the AC data of one multiplex frame shall be made equal to the number of AC carriers for the 203 symbols excluding symbol 0, which is the reference for differential modulation. A value of "1" shall be inserted (stuffing) in AC carrier positions not used for transmitting AC data.
- (3) AC data is multiplexed sequentially from data corresponding to AC carrier positions with lower frequencies to data with higher frequencies and from the MSB side of each packet. "Byte#" is a convenient name assigned to indicate the order of data within the multiplex frame.

Table 6-3 Order of multiplexing AC data

	Byte0	Byte1	Byte2	• • •
7 (MSB)	D0	D8	D16	
6	D1	D9	D17	
5	D2	D10	D18	
4	D3	D11	D19	
3	D4	D12	D20	
2	D5	D13	D21	
1	D6	D14	D22	
0 (LSB)	D7	D15	D23	

Mapped in the order of AC carriers of lower to higher frequencies, thus in the order of "D0, D1, D2, D3,..."

- (4) When a fraction of byte occurs in the multiplex frame by dividing the number of AC carriers on a byte basis, the last bytes of the last packet in the multiplex frame where AC data is multiplexed are stuffed with "1" (see the example below). The stuffed data is discarded in the modulator because only data corresponding to the AC carriers of one OFDM frame is acquired.

Example: mode 3, DQPSK, hierarchy A, 13 segments

AC1 carrier:  $8 \times 13 \times 203 = 21,112$  bits

AC2 carrier:  $19 \times 13 \times 203 = 50,141$  bits

Total of 71,253 bits (8,906.625 bytes)

The arrangement of AC data in this case is shown in Fig. 6-3, which only shows the packets where AC data is multiplexed and only AC data in each packet.

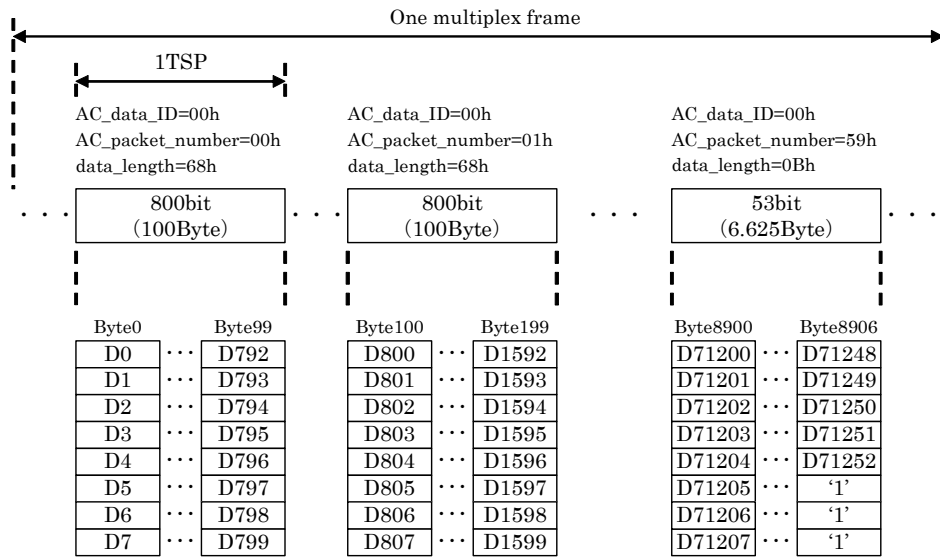

Fig. 6-3 Example of multiplexing on a multiplex frame (stuffing)

- (5) When AC data whose number of bits exceeds the maximum number that can be mapped to one OFDM frame is multiplexed on one multiplex frame, the part of the AC data beyond the maximum number counted from the head of the multiplex frame will be discarded.

Example: mode 3, DQPSK, hierarchy A, 13 segments  
AC1 carrier:  $8 \times 13 \times 203 = 21,112$  bits  
AC2 carrier:  $19 \times 13 \times 203 = 50,141$  bits  
Total of 71,253 bits (8,906.625 bytes)

When AC data consisting of 72,000 bits is multiplexed on the multiplex frame with the above number of bits that can be mapped, the AC data of 71,254th and subsequent bits will not be mapped to the OFDM frame, as shown in Fig. 6-4.

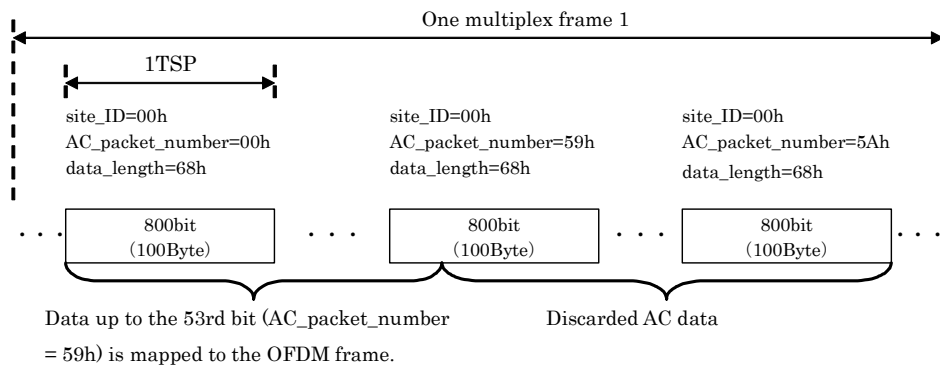
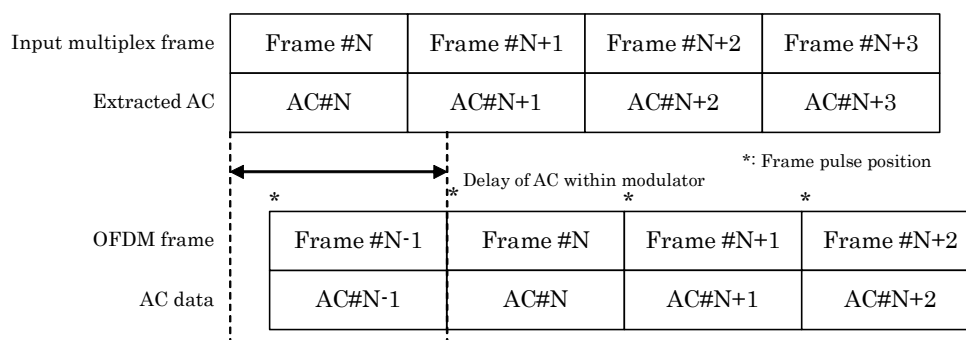

Fig. 6-4 Example of multiplexing data that exceeds the number of bits that can be mapped

### 6.3.4 Mapping to OFDM carriers

#### 6.3.4.1 Timing of multiplexing AC data in relation to OFDM frames

AC data multiplexed on the invalid hierarchy shall be transmitted in synchronization with the data sent by the multiplex frame to which the AC data belongs. Fig. 6-5 shows the transmission frame timing of AC data multiplexed on the invalid hierarchy.



Note: Indicates the case where the delay of signal processing in the main line system within the modulator is one frame plus  $\alpha$  fraction.

Fig. 6-5 Illustrated timing of mapping when data is multiplexed on the invalid hierarchy

#### 6.3.4.2 Procedure of mapping to OFDM carriers

Multiplexed AC data is mapped sequentially, regardless of AC1 or AC2, to AC carriers in the order of lower to higher frequencies. When mapping to all AC carriers of one symbol is finished, mapping advances to the next symbol.

Since the first OFDM frame symbol (symbol 0) is the reference for differential modulation for AC carriers, AC data is not mapped to this symbol. Within one multiplex frame, therefore, the amount of AC data mapped to AC carriers (including stuffed data if required) corresponds to 203 symbols.

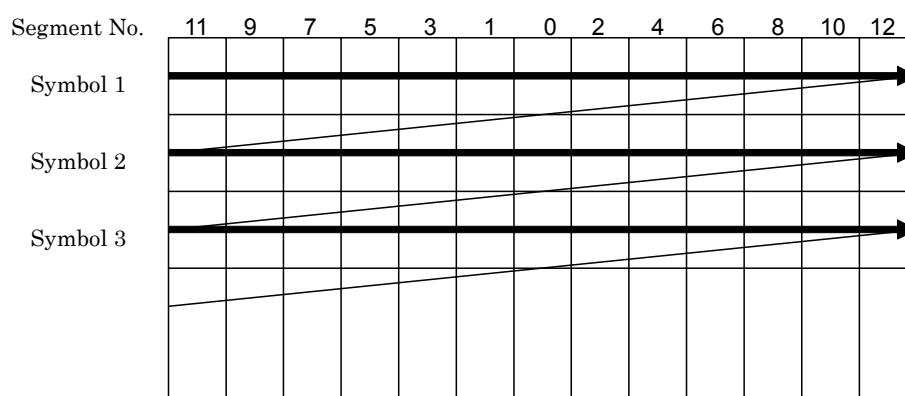

Fig. 6-6 Procedure of mapping to the AC carrier positions of OFDM

## 6.4 Considerations in multiplexing AC data to broadcasting TS

### 6.4.1 Considerations in the order of AC data carriers

When multiplexing AC data on broadcasting TS, it is necessary to understand which AC carriers are used to transmit AC data, in light of possible use of multiple lines and partial use of AC carriers. Suppose that sound system 3 (ADPCM, 64 kbps) shown in Table A2.2-1 of Section A2.2.1 in this Reference is multiplexed as AC data in a synchronization segment configuration where only AC1 can be used. Assuming that the OFDM transmission wave is in Mode 3, there are 104 AC1 carriers (8 carriers x 13 segments). Because multiplexed AC data corresponds to 92 carriers, the remaining 12 carriers need to be stuffed. At the multiplex positions corresponding to the stuffed carriers, stuffing is carried out on a bit basis during multiplexing on broadcasting TS with AC\_data\_invalid\_flag = "0" and AC\_data = "1".

Since multiplexed AC data is mapped sequentially, regardless of AC1 or AC2, to AC carriers in the modulator, AC data sorted and stuffed in advance will be multiplexed if distinction of segment allocation or distinction between AC1 and AC2 is required. Because delay time of AC data transmission depends on the processing of AC data during multiplexing, delay time during multiplexing on broadcasting TS must also be taken into account if AC data needs to be transmitted with little delay.

### 6.4.2 Considerations in the timing of multiplexing on dummy bytes

This section describes considerations in avoiding overflow or underflow between AC data multiplexed to dummy bytes and AC data actually transmitted as broadcasting wave at the OFDM modulator. AC data is modulated with DBPSK at the AC carriers of each symbol and then transmitted as broadcasting wave. However, AC data is not transmitted for the first symbol (symbol 0), which is the reference for differential modulation. AC data is therefore transmitted by symbols 1 to 203, excluding symbol 0, among the total of 204 symbols in one OFDM frame.

On the other hand, signals are processed (IFFT) on a symbol basis at the channel-coding IFFT block of the OFDM modulator. In the OFDM modulator, therefore, AC data to be transmitted needs to be input before or during the signal processing of a preceding symbol.

The OFDM frame defined here coincides with the multiplex frame. This means the head of the multiplex frame indicated by frame\_head\_packet\_flag in Table 5-7 in (2) of Section 5.5.2 in this Attachment corresponds to the head of the OFDM frame. The number of bytes in the transmission TSP corresponding to the duration of one symbol is shown in Table 6-4 for different situations.

Table 6-4 Number of bytes corresponding to the duration of one symbol

Mode	Number of bytes of transmission TSP for the duration of one symbol			
	Guard interval ratio 1/4	Guard interval ratio 1/8	Guard interval ratio 1/16	Guard interval ratio 1/32
Mode 1	1280	1152	1088	1056
Mode 2	2560	2304	2176	2112
Mode 3	5120	4608	4352	4224

It must be noted that AC data to be transmitted by the next symbol needs to be input to the OFDM modulator during or prior to the period required for transmitting the number of bytes of transmission TSP shown in Table 6-4 for the applicable mode and guard interval ratio.

(1) Guidelines on the underflow of AC data

The amount of AC data transmitted during the period of one symbol needs to be input to the OFDM modulator for each of symbols 0 to 202.

(2) Guidelines on the overflow of AC data

Given that AC data is transmitted in connection with the TSP transmitted by the same multiplex frame, the OFDM modulator has a buffer corresponding to the AC data amount of one OFDM frame. The buffer is renewed on a basis of multiplex frame defined in Table 5-7 in (2) of Section 5.5.2 in this Attachment. Thus, excessive AC data beyond the transmission limit for one OFDM frame is discarded in the OFDM modulator. AC data input during the period of symbol 203 is also discarded in the OFDM modulator.

<Blank Page>

## References



## References

### Contents

Reference 1: Transmission Delay Caused by the Channel Coding .....	121
Reference 2: Example of a Study on an AC (Auxiliary Channel) Transmission System .....	122
A2.1 Foreword.....	122
A2.2 Source coding.....	123
A2.2.1 Sound coding scheme .....	123
A2.2.2 Data-coding scheme .....	124
A2.3 Channel-coding scheme .....	125
A2.3.1 AC-packet configuration .....	125
A2.3.2 AC-packet bit assignment.....	126
A2.4 Descriptions of bits in AC data and packet-transmission sequence .....	129
A2.4.1 Descriptions of bits for AC-packet configuration 1 .....	129
A2.4.2 Description of bits for AC-packet configuration 2.....	132
A2.5 AC-packet transmission .....	136
A2.5.1 AC transmission capacity .....	136
A2.5.2 Number of Carriers Used .....	137
A2.5.3 Sound bit rate .....	137
A2.6 Case study on the timing of AC data transmission by dummy bytes .....	138
A2.6.1 Timing model study.....	138
A2.6.1.1 Timing model considering uniformity.....	138
A2.6.1.2 Timing model without considering uniformity.....	139
Reference 3: Considerations in the Link Budgets for ISDB-T.....	140
A3.1 Review procedure.....	141
A3.2 Assumptions made in link budget .....	141
A3.2.1 Network model .....	141
A3.2.2 Transmitter model.....	143
A3.2.3 Reception model within service area .....	147
A3.2.4 Provisional values selected for the link budget model .....	150

- A3.3 Example of link budget..... 151
- A3.4 Standard settings for transmitting equipment in network ..... 153
  - A3.4.1 Study on the impact of changes to provisional values on overall link budget..... 155
- A3.5 Corrective actions if model case requirements cannot be met ..... 157
  - A3.5.1 Corrective action if your stage-to-stage distance is longer than that in the model case ..... 157
  - A3.5.2 Corrective action if the multipath disturbance, SFN sneak path, and co-channel interference levels are higher than those in the model case ..... 157
  - A3.5.3 Corrective action when there are many stages..... 158
  - A3.5.4 Corrective action when multipath and radio-interference conditions within the service area are harsher than in the model case..... 158
- A3.6 Effect of changing transmission parameters, and problems ..... 158
- A3.7 Specific network construction process..... 159

## Reference 1: Transmission Delay Caused by the Channel Coding

The delays shown below occur as a result of interleaving steps conducted at the ISDB-T channel coding. This section shows examples of delays caused during the period between the TS re-multiplexing and guard-interval addition steps shown in Fig. 3-2 of Section 3.1, Chapter 3, in addition to delays caused during the period between the corresponding decoding steps.

Table A1-1: Transmission and Reception Delays (Number of Delayed Frames)  
Caused by the Channel Coding

Transmission mode	Mode 1	Mode 2	Mode 3
Byte interleaving	1 frame		
Bit interleaving	2 OFDM symbols		
Time interleaving	0 frames $/I = 0$	0 frames $/I = 0$	0 frames $/I = 0$
	2 frames $/I = 4$	1 frame $/I = 2$	1 frame $/I = 1$
	4 frames $/I = 8$	2 frames $/I = 4$	1 frame $/I = 2$
	8 frames $/I = 16$	4 frames $/I = 8$	2 frames $/I = 4$
Combining of hierarchical layers (transmitting side)	1 frame		
Combining of hierarchical layers (receiving side)	3TS packets		

Table A1-2: Transmission and Reception Delay Times Caused by the Channel Coding

Mode	Time interleaving	Number of delayed frames	Delay time			
			Guard-interval ratio: 1/4	Guard-interval ratio: 1/8	Guard-interval ratio: 1/16	Guard-interval ratio: 1/32
Mode 1	I = 0	3 frames	192.8 ms	173.5 ms	163.9 ms	159.0 ms
	I = 4	5 frames	321.3 ms	289.2 ms	273.1 ms	265.1 ms
	I = 8	7 frames	449.8 ms	404.8 ms	382.3 ms	371.1 ms
	I = 16	11 frames	706.9 ms	636.2 ms	600.8 ms	583.2 ms
Mode 2	I = 0	3 frames	385.6 ms	347.0 ms	327.7 ms	318.1 ms
	I = 2	4 frames	514.1 ms	462.7 ms	437.0 ms	424.1 ms
	I = 4	5 frames	642.6 ms	578.3 ms	546.2 ms	530.1 ms
	I = 8	7 frames	899.6 ms	809.7 ms	764.7 ms	742.2 ms
Mode 3	I = 0	3 frames	771.1 ms	694.0 ms	655.5 ms	636.2 ms
	I = 1	4 frames	1028.2 ms	925.3 ms	873.9 ms	848.2 ms
	I = 2	4 frames	1028.2 ms	925.3 ms	873.9 ms	848.2 ms
	I = 4	5 frames	1285.2 ms	1156.7 ms	1092.4 ms	1060.3 ms

Note: The above delay time has been calculated assuming that the total number of delays that develop as a result of processing, including time interleaving, byte interleaving, bit interleaving, and the combining of hierarchical layers, is 3 OFDM frames.

## Reference 2: Example of a Study on an AC (Auxiliary Channel) Transmission System

### A2.1 Foreword

The AC modulation scheme, amplitude, and carrier arrangement are discussed in Chapter 3 of the standard. However, no stipulations are made regarding its transmission system.

Trunk signals transmitted by digital terrestrial broadcasting are delayed as a result of steps including time interleaving, delay adjustment, multiplex-frame pattern formation, and the combining of hierarchical layers conducted at the channel coding and decoder. The transmission delay time varies from 0.1 seconds to approximately one second depending on the mode, guard-interval ratio, and time interleaving depth selected.

AC features a small delay time, although its transmission capacity is low. This reference discusses an example of an AC transmission system in which sound signals are transmitted using AC, in order to measure the delay time that develops during transmission of trunk sound.

Note that the examples shown in this study are premised on use of the same transmission system for both ISDB-T and ISDB-T<sub>SB</sub>.

## A2.2 Source coding

### A2.2.1 Sound coding scheme

Only the coding schemes shown in Table A2.2-1 are applicable to low-bit-rate sound that can be transmitted by AC. Note that all sampling frequencies must be 8.000 kHz.

Table A2.2-1: Coding-Scheme Specifications for Low-Bit-Rate Sound

Sound system		1	2	3	4	5
Coding scheme		PSI-CELP	ACELP	ADPCM	ADPCM	ADPCM
Bit rate [kbps]	Total	5.6	11.2	64	48	38.4
	Sound	3.45	6.7	32		
	Error correction	2.15	4.5	32	16	6.4
Sampling frequency [kHz]		8	8	8		
Frame length [ms]		40	20	5		
Subframe length [ms]		10	-	-		
Data bits/frame		138	134	160	160	160
Total bits/frame		224	224	320	240	192
Sound error correction		Convolutional	Convolutional	Convolutional-coding rate 1/2	Convolutional-coding rate 2/3	Convolutional-coding rate 5/6
Standard		ARIB Standard RCR STD-27H (Section 5.2)	ARIB Standard RCR STD-27H (Section 5.4)	ARIB Standard ITU-T Recommendation G.726		
Reference (communications system)		PDC	PDC	PHS, etc.		

(1) Sound system 1

The sound coding scheme and sound error-correction scheme for this system must satisfy the requirements specified in Section 5.2 of ARIB Standard RCR STD-27H.

(2) Sound system 2

The sound coding scheme and sound error-correction scheme for this system must satisfy the requirements specified in Section 5.4 of ARIB Standard RCR STD-27H.

(3) Sound coding scheme for sound systems 3 to 5

The sound coding scheme for these systems must satisfy the requirements specified in G.726 of the ITU-T Recommendations.

(4) Sound error-correction scheme for sound systems 3 to 5

The convolutional code, the mother code of which features constraint length  $k = 7$  and a coding rate of  $1/2$ , as with the trunk inner code, must be used for sound error correction for sound systems 3 to 5. Note, however, that three types of puncturing,  $1/2$ ,  $2/3$ , and  $5/6$ , must be available.

#### **A2.2.2 Data-coding scheme**

The data-coding scheme has yet to be determined.

## A2.3 Channel-coding scheme

### A2.3.1 AC-packet configuration

Two AC-packet configurations must be used, as shown in Fig. A2.3-1. There are no parity bits with configuration 1, though parity bits are available with configuration 2. The packet-configuration identifier must consist of three bits. The contents of this identifier must be 000 for configuration 1, and 111 for configuration 2. This identifier must not have any other contents.

Configurations 1 and 2 must be used when sound with little delay time is transmitted, and when data such as control data that must be highly reliable is transmitted, respectively.

Because the packet-configuration identifier consists of three bits, and because the contents of this identifier are either 000 or 111, it is possible to properly identify the AC-packet configuration in the presence of one incorrect bit among three bits.

Reference bit for differential modulation (C0) is generated in the modulator side. Therefore, the reference bit for differential modulation is not multiplexed on broadcasting TS, but 203 bits (C1 to C203) that correspond to packet header, data, and parity are multiplexed.

#### (1) Configuration 1 (without parity bits)

Reference bit for differential modulation  
(1bit)

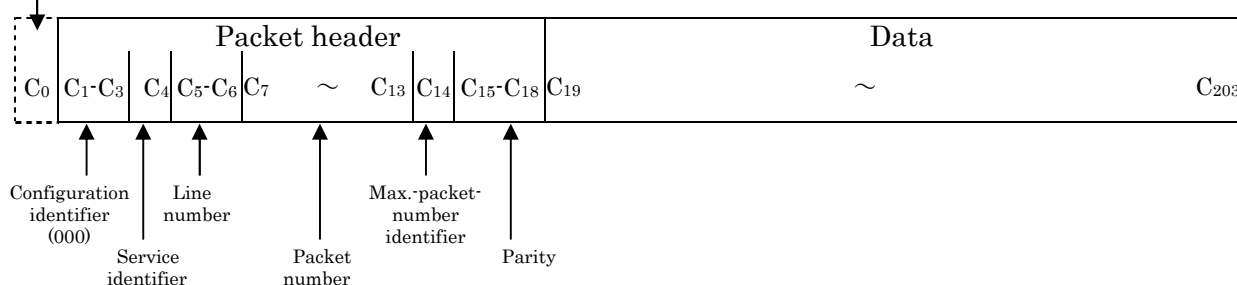

#### (2) Configuration 2 (with parity bits)

Reference bit for differential modulation  
(1bit)

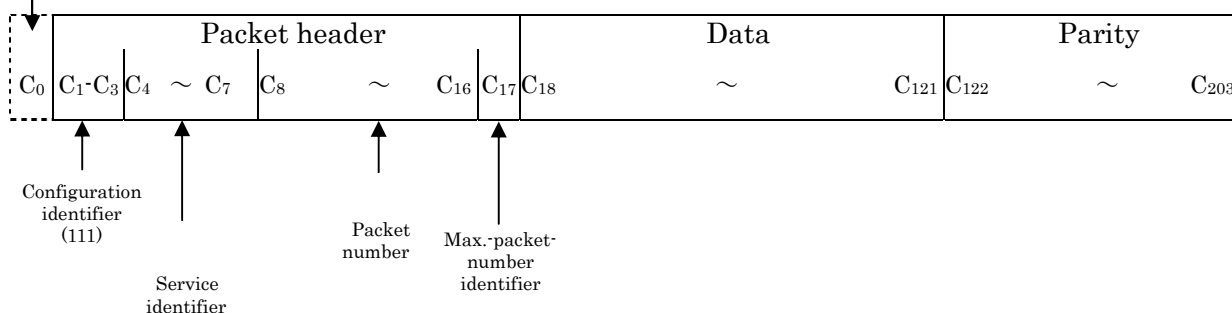

Fig. A2.3-1: AC-Packet Configuration

### A2.3.2 AC-packet bit assignment

Tables A2.3-1 and A2.3-2 show the bit assignments for AC-packet configurations 1 and 2, respectively.

Table A2.3-1: AC-packet configuration 1

Bit No.	Number of bits	Description	Remarks
C <sub>1</sub> – C <sub>3</sub>	3	Configuration identifier (000)	Identification of configuration 1 or 2 (Configuration 1)
C <sub>4</sub>	1	Service identifier	Two types (0: sound; 1: extension)
C <sub>5</sub> – C <sub>6</sub>	2	Circuit number	4 circuits max. (0 to 3)
C <sub>7</sub> – C <sub>13</sub>	7	Packet number	Packet sequence for sending sound data with circuit number n
C <sub>14</sub>	1	Max.-packet-number identifier	1 for max. packet number and 0 for any other number
C <sub>15</sub> – C <sub>18</sub>	4	Parity bits from C <sub>4</sub> to C <sub>14</sub> (11 bits)	Parity bits using (15,11) BCH code
C <sub>19</sub> – C <sub>203</sub>	185	Data	

Table A2.3-2: AC-packet configuration 2

Bit No.	Number of bits	Description	Remarks
C <sub>1</sub> – C <sub>3</sub>	3	Configuration identifier (111)	Identification of configuration 1 or 2 (Configuration 2)
C <sub>4</sub> – C <sub>7</sub>	4	Service identifier	16 types
C <sub>8</sub> – C <sub>16</sub>	9	Packet number	Packet sequence for each service-identifier content
C <sub>17</sub>	1	Max.-packet-number identifier	1 for the max. packet number and 0 for any other number
C <sub>18</sub> – C <sub>121</sub>	104	Data (13 bytes)	
C <sub>122</sub> –C <sub>203</sub>	82	Parity bits from C <sub>4</sub> to C <sub>121</sub> (118 bits)	Parity bits using the shortened code (200,118) of the (273,191) difference cyclic code

(1) Descriptions of bits for AC-packet configuration 1

(i) Service identifier ( $C_4$ )

The service identifier must be one bit in length. “0” in this bit indicates that sound is transmitted. When the content of this bit is 1, which indicates an extension, the assignment and descriptions of bits  $C_5$  onward are undefined.

(ii) Circuit number ( $C_5$  to  $C_6$ )

These bits represent one of circuits 0 to 3 for transmitting sound. Up to four circuits can be used simultaneously for transmission.

With ISDB-T, a 6-MHz channel band (with 13 segments) can transmit three standard-quality Television programs. Therefore, it is preferable to use at least three circuits for transmission simultaneously.

With ISDB-T<sub>SB</sub>, simultaneous transmission using four circuits may be difficult. However, to ensure that the ISDB-T<sub>SB</sub> standard is consistent with the ISDB-T standard, we have decided that up to four circuits may be used for transmission simultaneously.

(iii) Packet number ( $C_7$  to  $C_{13}$ )

These bits represent the sequence for sending packets that convey sound using circuit number  $n$  ( $n = 0$  to 3). When we let the number of packets in a frame with circuit number  $n$  be  $N$ , the packet numbers must be 0 to  $N-1$ .

In mode 3 and with a guard-interval ratio of 1/4, the bit rate for one carrier (185 bits) is  $185 \text{ bits}/257.04 \text{ msec} = 0.720 \text{ kbps}$ . Consequently, the bit rates for 8 carriers, 16 carriers, 64 carriers, and 128 carriers are 5.76 kbps, 11.52 kbps, 46.06 kbps, and 92.13 kbps, respectively. In order to ensure that signals generated by error-correcting 32-kbps ADPCM sound with a coding rate of 1/2 can be transmitted, the maximum number of packets must be 128 (7 bits).

(iv) Max.-packet-number identifier ( $C_{14}$ )

When we let the number of packets in a frame with circuit number  $n$  be  $N$ , this bit must contain 1 as the max.-packet-number identifier when the packet number is  $N-1$ , and 0 for any other packet number.

This flag is intended to indicate how many packets within a frame are used to transmit sound with circuit number  $n$ .

(v) Packet-header parity bits ( $C_{15}$  to  $C_{18}$ )

Eleven (11) bits  $C_4$  to  $C_{14}$  of the packet header must be error-protected using the (15,11) BCH code that can correct one bit error. The generating polynomial must be as follows:

$$g(x) = x^4 + x + 1$$

(vi) Data ( $C_{19}$  to  $C_{203}$ )

Bits  $C_{19}$  to  $C_{203}$  must be data that transmits sound.

(2) Descriptions of bits for AC-packet configuration 2

(i) Service identifier ( $C_4$  to  $C_7$ )

The service identifier must consist of 4 bits. “0000” indicates that AC transmission information is included in the packet. All other values are undefined.

(ii) Packet number ( $C_8$  to  $C_{16}$ )

These bits represent the sequence for sending packets for each service-identifier content. When we let the number of packets in a frame with service-identifier value  $x$  be  $N$ , the packet numbers must be 0 to  $N-1$ .

The total number of AC carriers is 351 when mode 3 and 13 segments are selected. Because nine (9) bits ( $2^9 - 1 = 511$ ) are assigned to packet numbers, all carriers can be accommodated.

In mode 3 and with a guard-interval ratio of 1/4, the bit rate for one carrier (104 bits) is 104 bits/257.04 msec = 0.405 kbps. When all 351 carriers are used, the bit rate will be 142 kbps.

(iii) Max.-packet-number identifier ( $C_{17}$ )

When we let the number of packets in a frame with service-identifier value  $x$  be  $N$ , this bit must contain 1 as the max.-packet-number identifier when the packet number is  $N-1$ , and 0 for any other value.

This flag is intended to indicate how many packets within a frame are used to transmit data with service-identifier value  $x$ .

(iv) Data ( $C_{18}$  to  $C_{121}$ )

Bits  $C_{18}$  to  $C_{121}$  must be data transmitted with AC-packet configuration 2.

(v) Parity bits ( $C_{122}$  to  $C_{203}$ )

Bits  $C_{122}$  to  $C_{203}$  must be parity bits for 118 bits from  $C_4$  to  $C_{121}$ . The shortened code (200,118) of the (273,191) difference cyclic code must be used as the error-correction code.

The generating polynomial of the (273,191) code is shown below. Note that this polynomial is identical to that of the TMCC error-correction code.

$$g(x) = x^{82} + x^{77} + x^{76} + x^{71} + x^{67} + x^{66} + x^{56} + x^{52} + x^{48} + x^{40} + x^{36} + x^{34} + x^{24} + x^{22} + x^{18} + x^{10} + x^4 + 1$$

## A2.4 Descriptions of bits in AC data and packet-transmission sequence

### A2.4.1 Descriptions of bits for AC-packet configuration 1

The descriptions of bits in data transmitted with packet configuration 1 are as shown below.

#### (1) Sound-frame configuration

The number of bits in one sound-signal frame, including parity bits, is as shown in Table A2.2-1. A 5-bit synchronizing signal must be added to the beginning of each frame. Three sound frames must be used to make up one super sound frame. A 3-bit stuffing-bit identifier must be added after the 5-bit synchronizing signal of the third frame in a super sound frame, in order to adjust the number of stuffing bits for each frame.

Fig. A2.4-1 shows the super sound frame configuration, while Tables A2.4-1 and A2.4-2 provide descriptions of bits in a super sound frame and specify the number of stuffing bits, respectively. Note that sound frames are independent of OFDM frames.

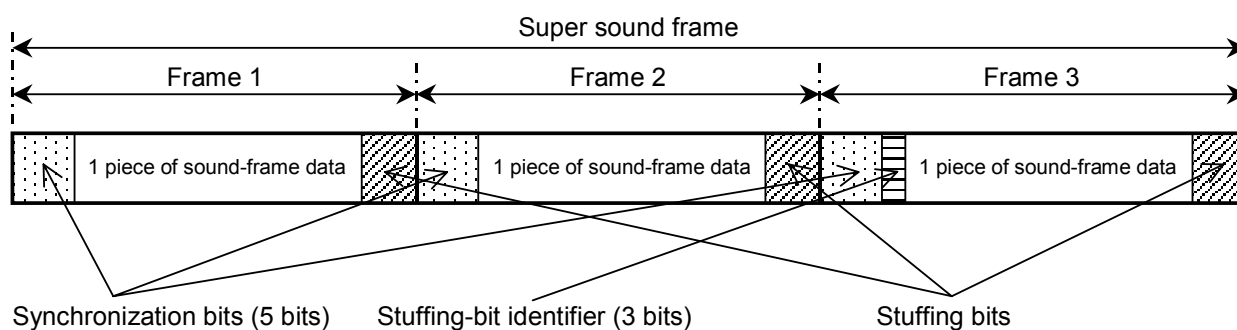

Fig. A2.4-1: Configuration of a Super Sound Frame

Table A2.4-1: Description of Bits in a Super Sound Frame

Description	Bits/frame	Frame 1	Frame 2	Frame 3	Remarks
Synchronization bits	5 bits	00100	11010	11110	FC0 = (00100 11010 11110) FC1 = (11011 00101 00001) FC0 and FC1 alternate every super frame.
		11011	00101	00001	
Stuffing-bit identifier	-	-	-	000	SB0 = (000), SB1 = (111)
		-	-	111	
Sound-frame data	See Table A2.2-1.	-	-	-	Varies depending on the sound-coding scheme
Stuffing bits	See Table A2.4-2.	-	-	-	Varies depending on the sound-coding scheme

Table A2.4-2: Numbers of Stuffing Bits

Guard-Interval Ratio	SB0/SB1	Frame No.	Sound-coding scheme 1	Sound-coding scheme 2	Sound-coding scheme 3	Sound-coding scheme 4	Sound-coding scheme 5
1/4	SB0	Frame 1	0	0	5	13	3
		Frame 2	0	0	5	13	3
		Frame 3	0	0	5	13	3
	SB1	Frame 1	0	0	5	13	3
		Frame 2	0	0	5	13	3
		Frame 3	0 + 1	0 + 1	5 + 1	13 + 1	3 + 2
1/8	SB0	Frame 1	25	25	41	41	25
		Frame 2	25	25	41	41	25
		Frame 3	25	25	41	41	25
	SB1	Frame 1	25	25	41	41	25
		Frame 2	25	25	41	41	25
		Frame 3	25 + 3	25 + 3	41 + 2	41 + 3	25 + 3
1/16	SB0	Frame 1	40	40	63	58	39
		Frame 2	40	40	63	58	39
		Frame 3	40	40	63	58	39
	SB1	Frame 1	40	40	63	58	39
		Frame 2	40	40	63	58	39
		Frame 3	40 + 3	40 + 3	63 + 2	58 + 3	39 + 1
1/32	SB0	Frame 1	49	49	75	68	46
		Frame 2	49	49	75	68	46
		Frame 3	49	49	75	68	46
	SB1	Frame 1	49	49	75	68	46
		Frame 2	49	49	75	68	46
		Frame 3	49 + 1	49 + 1	75 + 1	68 + 1	46 + 1

(2) Assignment of sound-frame data to AC packets

To minimize transmission delay, AC sound data (shown in (1)) must be assigned to packets as shown in Fig. A2.4-2.

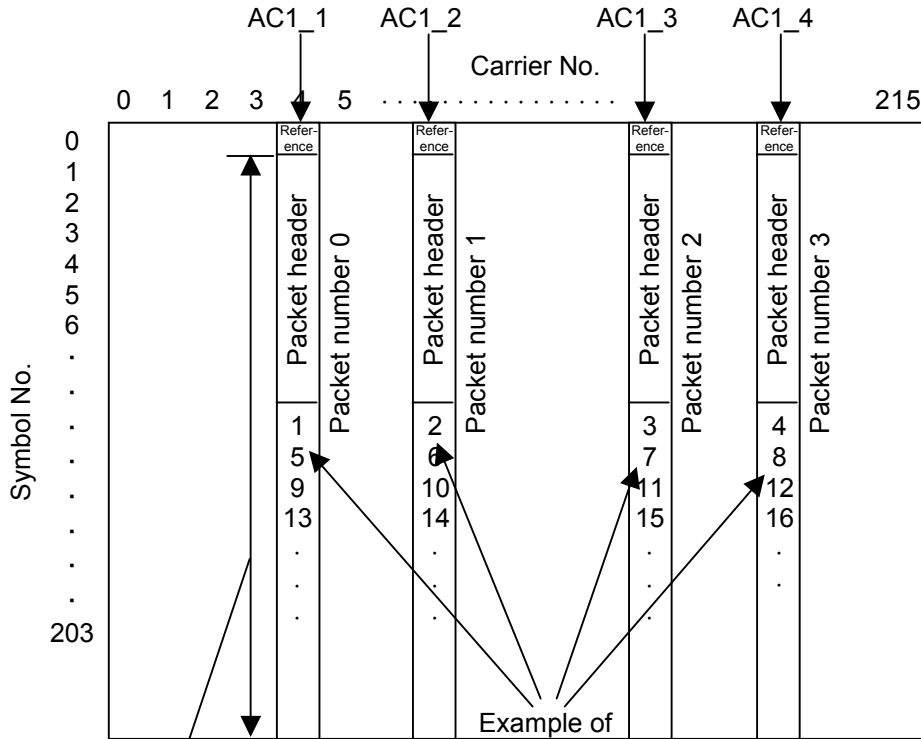

### A2.4.2 Description of bits for AC-packet configuration 2

Descriptions of bits in data transmitted with packet configuration 2 are given below.

Note that the data specified below is available when the service identifier in the packet header of AC-packet configuration 2 contains “0000.” Note also that the descriptions of bits are undefined if the service identifier contains a value other than “0000.”

#### (1) Basic data configuration

Table A2.4-3 shows the basic data configuration when the service identifier of AC-packet configuration 2 contains “0000.”

Table A2.4-3: Basic Data Configuration for AC-packet configuration 2 (“0000” in Service Identifier)

Number of bits	Description	Remarks
8	Data-body identifier	Data-body identifier 00h: Indicates the data body transmitted with an AC (AC transmission information) 01h: Indicates that the data body contains additional information on sound transmitted with packet configuration 1 (sound transmission information) Others: Undefined
8	Number of bytes transmitted	Represents the number of bytes $((x + y) / 8)$ available from the beginning of the data body to the end of the supplementary bits. Note that if this number is FFh, two bytes will be added as extension bits to indicate the number of bytes transmitted.
x	Data body	Body of data to be transmitted
y (0~7)	Supplementary bits (null bits)	Supplementary bits used to ensure that $x + y$ is an integer. Each of these bits must contain 0. $y = \text{mod} \{8 - \text{mod}(x, 8), 8\}$
16	16-bit CRC	CRC provided to detect errors bits from the data-body identifier to supplementary bits Generating polynomial: $g(x) = x^{16} + x^{12} + x^5 + 1$

(2) AC transmission information

(i) Data body

Table A2.4-4 provides descriptions of bits in the data body (number of bits = x) presented in Table A2.4-3.

Table A2.4-4: Descriptions of Bits When the Data Body Contains AC Transmission Information

Number of bits	Description	Remarks	Nesting
1	Distinction between current and next information	0: AC transmission configuration being transmitted 1: AC transmission configuration after changes are made The next information must be transmitted after the current information.	0
1	Distinction between AC-packet configuration types	0: AC-packet configuration 1 1: AC-packet configuration 2	1
2	AC-packet transmission information	00: Not transmitted (will not be transmitted) 01: Transmitted (will be transmitted) 10: Undecided 11: Undefined	1
4	Service identifier and circuit No.	Configuration 1 (First 2 bits) 00: Sound 01: Extension (Next 2 bits): Circuit number 00 to 11: Circuit number Configuration 2 0000: Transmission information 0001 to 1111: Undefined	2
1	Service-identifier transmission information	0: Not transmitted (will not be transmitted) 1: Transmitted (will be transmitted)	2
2	AC-carrier identifier	00: Undefined 01: AC1 carriers used 10: AC2 carriers used 11: Both AC1 and AC2 carriers used	3
8 (16)	Max. packet number	Represents the max. number of packets for each value in the service identifier (circuit identifier). When the number of packets is N, the maximum number of packets is expressed as N-1. When the contents of these bits are FFh, one byte will be added. This additional byte will be used to represent the number of packets (N-255). N = 1: 00h N = 255: FEh N = 256: FF00h N = 257: FF01h	3
4	Number of carriers carrying the same packet	Represents the number of AC carriers transmitting the same data. There is only one AC carrier when the contents of these bits are "0000."	3
4	Start segment No.	Represents the start segment number (0 to 12)	4
5	Start AC-carrier No.	Represents the start AC-carrier number (0 to 27)	4

Note 1: Nesting

- When “1” or a larger number is given under “Nesting,” the next information is transmitted after the current information.
- When “2” or a larger number is given under “Nesting,” that bit or those bits are transmitted if the contents of the AC-packet transmission identifier are “01” (transmitted).
- When “3” or a larger number is given under “Nesting,” those bits are transmitted if the content of the service-identifier transmission information is “1” (transmitted).
- When “4” is given under “Nesting,” those bits are transmitted as many times as the number of carriers carrying the same packet.

Note 2: AC carrier number

- The number of AC carriers used varies depending on the mode. The largest number of AC carriers is used in mode 3.
- When using both AC1 and AC2 carriers without any differentiation, AC1 and AC2 carriers must be numbered serially, beginning from the AC carrier position with the lowest frequency regardless of AC1 or AC2.

Note 3: End segment number and end AC-carrier number

- When a series of information (identical service number, identical circuit number) is transmitted using multiple AC carriers, consecutive AC carriers must be used. Because the maximum packet number, start segment number, and start AC-carrier number are given, the end segment number and end AC-carrier number can be obtained. Therefore, the end segment number and end AC-carrier number must not be sent.

(ii) Data volume

The data volume becomes minimal, or 14 bits (00001001000100) in length, when AC information is transmitted by neither the current nor the next information. The total data volume obtained by adding the basic data shown in Table A2.4-3 to the above data is six bytes. Therefore, all data can be transmitted using a single packet.

(iii) Limitations on transmission

When information is transmitted using an AC, it is preferable that the service identifier of AC-packet configuration 2 and the data-body identifier be set to 0000 and 00h, respectively, for sending AC transmission information.

(3) Sound transmission information

(i) Data body

Table A2.4-5 shows descriptions of bits in the data body (number of bits = x) presented in Table A2.4-3.

Table 2.4-5: Descriptions of Bits When the Data Body Contains Sound Transmission Information

Number of bits	Description		Remarks	Nesting
3	Number of circuits (B)		Represents the number of circuits used when sound signals are transmitted with AC-packet configuration 1. No sound signals are transmitted using an AC when these bits contain "0."	0
3	Sound system	Repeatedly transmitted as many times as the number of circuits	Represents the sound system used for each circuit 0: Sound system 1; 1: Sound system 2; 2: Sound system 3; 3: Sound system 4; 4: Sound system 5; 5 or other: Undefined	1
7	Number of packets		Represents the number of packets in the OFDM frame transmitted with each circuit	1

(ii) Data volume

The data volume becomes maximal, or  $3 + 10 \times 3 = 33$  bits, when 4-circuit sound signals are transmitted. The total data volume obtained by adding the basic data shown in Table A2.4-3 to the above data is nine bytes when the service identifier for AC-packet configuration 2 and the data-body identifier are set to 0000 and 01h. Therefore, all data can be transmitted using a single packet.

(iii) Limitations on transmission

When sound signals are transmitted using AC-packet configuration 1, it is preferable to transmit the number of circuits used for sound signals and the coding scheme by setting the service identifier of AC-packet configuration 2 and the data-body identifier to 0000 and 01h, respectively.

(iv) Timing and frequency with which sound signals are transmitted

When sound signals are transmitted using AC-packet configuration 1, it is preferable to transmit them prior to and during the transmission of sound signals by setting the service identifier of AC-packet configuration 2 and the data-body identifier to 0000 and 01h, respectively. Note also that it is preferable to transmit the sound signals at least every 5 seconds.

## A2.5 AC-packet transmission

### A2.5.1 AC transmission capacity

Table 2.5-1: Transmission capacity with AC-Packet Configuration 1 (1 Carrier = 185 bits)

Mode	Guard-in terval ratio	Frame length (ms)	Transmission capacity (kbps)						
			Per carrier	Per segment		Per3 segment		Per13 segment	
				AC1 only	AC2 only	AC1 only	AC2 only	AC1 only	AC2 only
1	1/4	64.2600	2.879	5.76	11.52	17.27	34.55	74.85	149.70
	1/8	57.8340	3.199	6.40	12.80	19.19	38.39	83.17	166.34
	1/16	54.6210	3.387	6.77	13.55	20.32	40.64	88.06	176.12
	1/32	53.0145	3.490	6.98	13.96	20.94	41.88	90.73	181.46
2	1/4	128.5200	1.439	5.76	12.96	17.27	38.87	74.85	168.42
	1/8	115.6680	1.599	6.40	14.39	19.19	43.18	83.17	187.13
	1/16	109.2420	1.693	6.77	15.24	20.32	45.72	88.06	198.14
	1/32	106.0290	1.745	6.98	15.70	20.94	47.11	90.73	204.14
3	1/4	257.0400	0.720	5.76	13.67	17.27	41.02	74.85	177.77
	1/8	231.3360	0.800	6.40	15.19	19.19	45.58	83.17	197.53
	1/16	218.4640	0.847	6.77	16.09	20.32	48.27	88.07	209.16
	1/32	212.0580	0.872	6.98	16.58	20.94	49.73	90.73	215.48

Table 2.5-2: Transmission capacity with AC-packet configuration 2 (1 Carrier = 104 bits)

Mode	Guard-in terval ratio	Frame length (ms)	Transmission capacity (kbps)						
			Per carrier	Per segment		Per3 segment		Per13 segment	
				AC1 only	AC2 only	AC1 only	AC2 only	AC1 only	AC2 only
1	1/4	64.2600	1.618	3.24	6.47	9.71	19.42	42.08	84.16
	1/8	57.8340	1.798	3.60	7.19	10.79	21.58	46.75	93.51
	1/16	54.6210	1.904	3.81	7.62	11.42	22.85	49.50	99.01
	1/32	53.0145	1.962	3.92	7.85	11.77	23.54	51.00	102.01
2	1/4	128.5200	0.809	3.24	7.28	9.71	21.85	42.08	94.68
	1/8	115.6680	0.899	3.60	8.09	10.79	24.28	46.75	105.20
	1/16	109.2420	0.952	3.81	8.57	11.42	25.70	49.50	111.39
	1/32	106.0290	0.981	3.92	8.83	11.77	26.48	51.00	114.76
3	1/4	257.0400	0.405	3.24	7.69	9.71	23.06	42.08	99.94
	1/8	231.3360	0.450	3.60	8.54	10.79	25.63	46.75	111.04
	1/16	218.4640	0.476	3.81	9.04	11.43	27.13	49.51	117.58
	1/32	212.0580	0.490	3.92	9.32	11.77	27.95	51.00	121.14

## A2.5.2 Number of Carriers Used

Table A2.5-3 shows the number of carriers required to transmit five (5) types of sound having AC-packet configuration 1, and additional sound-related information having AC-packet configuration 2.

Table A2.5-3: Number of Carriers Used

		Sound system 1	Sound system 2	Sound system 3	Sound system 4	Sound system 5	Additional sound information
Number of carriers	Mode 1	2	4	23	18	14	1
	Mode 2	4	8	46	36	28	1
	Mode 3	8	16	92	72	56	1
Number of segments (simultaneously modulated)	Mode 1,2,3	1	2	12	9	7	1
Number of segments (differentially modulated)	Mode 1,2,3	1	1	4	3	3	1

## A2.5.3 Sound bit rate

The sound bit rate is as shown below when 185 bits per AC packet are transmitted using AC-packet configuration 1. Note that the bit rate does not vary depending on the mode, but on the guard-interval ratio.

Table A2.5-4: Bit Rate for Sound with Synchronization Bits

Mode	Guard-interval ratio	Frame length (ms)	Bit rate per carrier (kbps)	2 carriers (M1)	4 carriers (M1)	14 carriers (M1)	18 carriers (M1)	23 carriers (M1)
				4 carriers (M2)	8 carriers (M2)	28 carriers (M2)	36 carriers (M2)	46 carriers (M2)
		(ms)	(kbps)	8 carriers (M3)	16 carriers (M3)	56 carriers (M3)	72 carriers (M3)	92 carriers (M3)
				(kbps)	(kbps)	(kbps)	(kbps)	(kbps)
1	1/4	64.2600	2.88	5.76	11.52	40.31	51.82	66.22
	1/8	57.8340	3.20	6.40	12.80	44.78	57.58	73.57
	1/16	54.6210	3.39	6.77	13.55	47.42	60.97	77.90
	1/32	53.0145	3.49	6.98	13.96	48.85	62.81	80.26
2	1/4	128.5200	1.44	5.76	11.52	40.31	51.82	66.22
	1/8	115.6680	1.60	6.40	12.80	44.78	57.58	73.57
	1/16	109.2420	1.69	6.77	13.55	47.42	60.97	77.90
	1/32	106.0290	1.74	6.98	13.96	48.85	62.81	80.26
3	1/4	257.0400	0.72	5.76	11.52	40.31	51.82	66.22
	1/8	231.3360	0.80	6.40	12.80	44.78	57.58	73.57
	1/16	218.4640	0.85	6.77	13.55	47.42	60.97	77.91
	1/32	212.0580	0.87	6.98	13.96	48.85	62.81	80.26

## A2.6 Case study on the timing of AC data transmission by dummy bytes

Regarding AC data transmission by dummy bytes, the followings are several timing models of TSP with AC\_data\_invalid\_flag = "0" (hereinafter referred to as "AC data dummy byte transmission TSP") among TSPs input to the OFDM modulator, which are studied in accordance with Section 6.4.2 "Considerations in the timing of multiplexing on dummy bytes" in the Appendix.

### A2.6.1 Timing model study

#### (1) Premises

- Mode and guard ratio: Mode 3, ratio = 1/8
- AC carriers used: only AC1 (all 13 segments are synchronized)
- AC\_data\_effective\_position = "1" (dummy byte data is used)
- AC\_data\_effective\_bytes = "00" (1 byte used)

#### (2) Basic data (Mode 3, guard ratio = 1/8)

- Number of transmission TSPs (all transmission TSPs) contained in one OFDM frame = 4608 [TSP]
- Number of TSPs corresponding to one symbol =  $4608 \div 204$  [symbol] = 22.58824 [TSP]
- Amount of AC data sent by one symbol = 13 [seg] x 8 [bit] = 13 [byte] (only AC1)
- Amount of AC data sent by one OFDM frame [symbol] = 13 [byte] x 203 = 2639 [byte] (only AC1)
- Amount of AC data sent by one TSP = 1 [byte] (1 dummy byte used)
- Number of AC data dummy byte transmission TSPs in one OFDM frame = 2639 [TSP]

#### A2.6.1.1 Timing model considering uniformity

Regarding AC data input to the OFDM modulator as dummy bytes, a timing model considering uniformity in the OFDM frame is studied. This model allows for minimization of required buffer capacity for AC data in the OFDM modulator.

From the basic data, about 22 TSPs correspond to the duration of one symbol. Two types with different numbers of unit block TSPs (22 and 23 TSPs) are defined in consideration of fractions. The number of AC data dummy byte transmission TSPs for the duration of each symbol shall be 13 for symbols 0 to 202. Thus, the number of AC data dummy byte transmission TSPs per unit block is 13. Because the amount of AC data to be transmitted only needs to be input in each unit block, the pattern of AC data dummy byte transmission TSPs in the unit block is not defined. Based on the above consideration, two timing models are defined:

#### (i) When unit blocks are divided into three parts for transmission in the OFDM frame

##### o Data configuration

- All transmission TSPs  
 $22$  [TSP] x  $84$  +  $23$  [TSP] x  $120$  =  $4608$  [TSP]

- AC data dummy byte transmission TSPs  
 $13$  [TSP] x  $84$  +  $13$  [TSP] x  $119$  =  $2639$  [TSP]

##### o Timing model (expressed in the form of "number of AC data dummy byte transmission TSPs / number of unit block TSPs")

- Unit blocks 0 to 83

- 13 / 22 x 84
- Unit blocks 84 to 202
- 13 / 23 x 19
- Unit block 203
- 0 / 23 x 1

(ii) When 17 symbols are taken as one unit for transmission in consideration of repetition

- Data configuration
  - All transmission TSPs  
 $(22 \text{ [TSP]} \times 7 + 23 \text{ [TSP]} \times 10) \times 12 = 4608 \text{ [TSP]}$
  - AC data dummy byte transmission TSPs  
 $(13 \text{ [TSP]} \times 7 + 13 \text{ [TSP]} \times 10) \times 11 + (13 \text{ [TSP]} \times 7 + 13 \text{ [TSP]} \times 9) \times 1 = 2639 \text{ [TSP]}$
- Timing model (expressed in the form of "number of AC data dummy byte transmission TSPs / number of unit block TSPs")
  - Unit blocks 0 to 186  
 $((13 / 22 \times 7) + (13 / 23 \times 10)) \times 11$
  - Unit blocks 187 to 203  
 $((13 / 22 \times 7) + (13 / 23 \times 9) + (0 / 23 \times 1))$

#### A2.6.1.2 Timing model without considering uniformity

Regarding AC data input to the OFDM modulator by dummy bytes, a timing model without considering uniformity in the OFDM frame is studied. This model allows for maximization of required buffer capacity for AC data in the OFDM modulator.

(i) When all AC data dummy byte transmission TSPs are input sequentially from the head of the OFDM frame

- Data configuration
  - All transmission TSPs  
4608 [TSP]
  - AC data dummy byte transmission TSPs  
2639 [TSP]

○ Timing model

Among all 4608 transmission TSPs, the first 2639 TSPs from the head of the OFDM frame are AC data dummy byte transmission TSPs and the remaining 1969 TSPs are not.

### **Reference 3: Considerations in the Link Budgets for ISDB-T**

To create a broadcast-wave network for ISDB-T, it is necessary to design link budget between the studio output and the receiver in accordance with the noise (permissible degradation) allocated to the transmitting side.

In the link budgets, the performance of each piece of broadcasting equipment must be determined. At the same time, the reception quality in the previous stage and across the service area must be specified when broadcast waves are relayed.

A broadcast network in particular is predicated on broadcast waves being received by multiple recipients (receivers). Therefore, it is necessary to create a network capable of withstanding the harshest conditions within the service area (fringe in general).

However, conditions associated with signal propagation, such as multipath disturbance and radio interference disturbance, vary depending not only on individual relay stations, but also on the locations at which receiving antennas are installed within the service area.

For this reason, we have developed a broadcasting-network model and reception model within the service area based on the current conditions under which analog broadcasting networks are operating and the Fiscal 1999 Report of the Frequency Planning Technical Committee of the Telecommunication Technology Council.

Because it may be difficult to satisfy the model case requirements or these requirements may be discovered to be excessively rigorous during the actual network construction process, the design must be reviewed based on the results of review given in this document.

### A3.1 Review procedure

In the review steps shown in Section A3.2 onward, we used the following procedure to present considerations in the link budgets, assuming that broadcast waves would be relayed:

- (1) We selected hypothetical stage-to-stage distances between broadcasting stations, and hypothetical levels of radio interference and multipath disturbance within the service area. We selected a network model extending from the studio output to receivers.
- (2) We assumed that broadcast waves would be received by stationary receivers. We also assumed that receiving systems (e.g., antenna and booster conditions) based on the Fiscal 1999 Report of the Frequency Planning Technical Committee of the Telecommunication Technology Council would be used.
- (3) In the link budgets, we selected provisional values based on our assumptions - provisional equivalent C/N ratios for various types of interference-affected broadcasting equipment, receivers, and channels (C/N ratios determined by treating equipment deterioration and various types of interference as noise).

### A3.2 Assumptions made in link budget

#### A3.2.1 Network model

- (1) Stage-to-stage distance

We conducted a survey of 2,485 analog stations across the country to determine the distance from the main station to the 1st-stage relay station, as well as the distances between relay stations at various stages, and selected stage-to-stage distances that include 80% of all stations.

Table A3.2-1: Stage-to-Stage Distances in an Analog Broadcasting Network

	Stage-to-stage distance				
	50% value	80% value	90% value	95% value	99% value
Main station – 1st stage	30.1 km	52.5 km	66.8 km	78.5 km	118.4 km
1st stage – 2nd stage	12.3 km	25.1 km	32.5 km	40.9 km	61.7 km
2nd stage – 3rd stage	11.6 km	23.1 km	31.3 km	39.9 km	57.2 km
3rd stage – 4th stage	7.4 km	16.3 km	25.3 km	41.1 km	67.7 km
4th stage – 5th stage	10.9 km	23.7 km	49.8 km	64.5 km	95.4 km
5th stage – 6th stage	4.7 km	9.5 km	17.9 km	21.4 km	38.3 km
6th stage – 7th stage	2.6 km	5.8 km	5.8 km	5.8 km	5.8 km

(2) Fading loss during the relaying of broadcast waves

We selected fading loss for each stage-to-stage distance (value that includes 80% of all stations selected in (1)) under the assumption that 99.9% fading margin will be available.

**Table A3.2-2: 99.9% Fading Margin Selected Based on a Stage-to-Stage Distance Acceptable for 80% of All Stations**

Relay station	To 1st Stage	To 2nd Stage	To 3rd Stage	To 4th Stage	To 5th Stage	To 6th Stage	To 7th Stage
Stage-to-stage distance	52.5 km	25.1 km	23.1 km	16.3 km	23.7 km	9.5 km	5.8 km
Fading loss	13.1 dB	8.7 dB	8.4 dB	7.3 dB	8.5 dB	6.7 dB	4.1 dB

(3) Maximum number of stages

With the current analog broadcasting network, broadcast waves are relayed by up to seven stages. However, we selected four stages as the maximum number of stages for the model case for which we implemented the link budget.

**Table A3.2-3: Number of Analog (Relay) Broadcasting Stations Included in Each Stage**

	Main station	1st stage	2nd stage	3rd stage	4th stage	5th stage	6th stage	7th stage
Number of stations	54	975	761	452	211	62	21	3
Total number of stations	54	1,029	1,790	2,242	2,453	2,515	2,536	2,539

### A3.2.2 Transmitter model

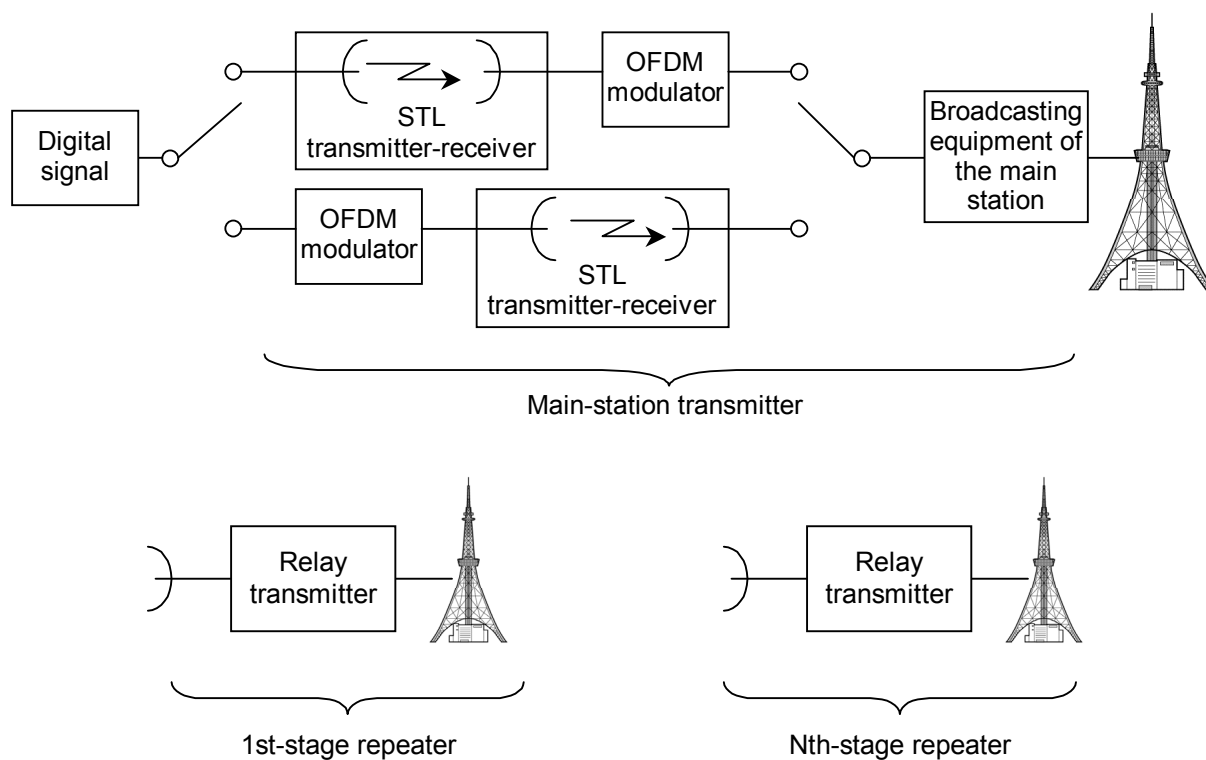

Fig. A3.2-1: Transmission-Circuit Model

#### (1) Transmission channel

The transmission channel determines the affects of urban noise, receiving-antenna gain, on the conversion of field strength to terminal voltage. The higher the channel frequency, the lower the level of urban noise and the higher the receiving-antenna gain. In contrast, the lower the channel frequency, the longer the effective antenna length (the higher the converted terminal voltage). In this link budget, we selected 13 channels, which is a generally rigorous condition.

(2) Broadcasting equipment at the main station

Broadcasting equipment at the main station must consist of an STL transmitter-receiver, OFDM modulator, and main-station transmitter.

As shown in Fig. A3.2-1, different signals are transmitted by the STL transmitter-receiver, depending on the location of the OFDM modulator.

If the OFDM modulator is provided at the transmitting station, the STL transmitter-receiver sends the digital signal (TS signal) to the transmitting station, where TS is reproduced and then modulated by the OFDM modulator (hereinafter referred to as the “TS transmission system”).

On the other hand, if the OFDM modulator is provided at the studio, the STL transmitter-receiver sends the waves modulated by the OFDM modulator to the transmitting station as is (hereinafter referred to as the “IF transmission system”).

The above two cases were reviewed.

- Case 1 (TS transmission system)

When the TS transmission system is used, TS is reproduced at the transmitting station. Therefore, it is not necessary to consider any degradation caused by the STL circuit in the link budget process.

As a result, only the possible degradation from the OFDM modulator onward should be calculated.

As the provisional equivalent C/N ratio of the transmitter, we selected 45 dB. The two main factors in degradation of the transmitter’s C/N ratio are IM and phase noise.

As for degradation caused by phase noise, we selected 50 dB as the equivalent C/N ratio.

It is known that IM can vary depending on whether a PD (predistortion) or FF (feedforward) system is used.

In general, a PD system provides relatively high efficiency but cannot ensure linearity, while an FF system ensures linearity but not high efficiency.

Because the main station’s transmitter likely has a high transmission output, we selected 40 dB as the IM, under the assumption that a PD system was used.

The study conducted using an actual transmitter shows that the equivalent C/N ratio is 2 dB lower than the value obtained by inverting the a sign of IM. Therefore, we selected 38 dB as the provisional equivalent C/N ratio of the main station’s transmitter caused by IM.

- Case 2 (IF transmission system)

When an IF transmission system is used, the OFDM signal is sent from the studio to the main station's transmitter. Therefore, it is necessary to calculate the level of degradation caused by the STL circuit. We selected 37.7 dB as the equivalent C/N ratio (sum of the C/N ratios of the STL transmitter-receiver and the main station's transmitter) to enable the C/N ratio for the main-station output in case 1 to be secured.

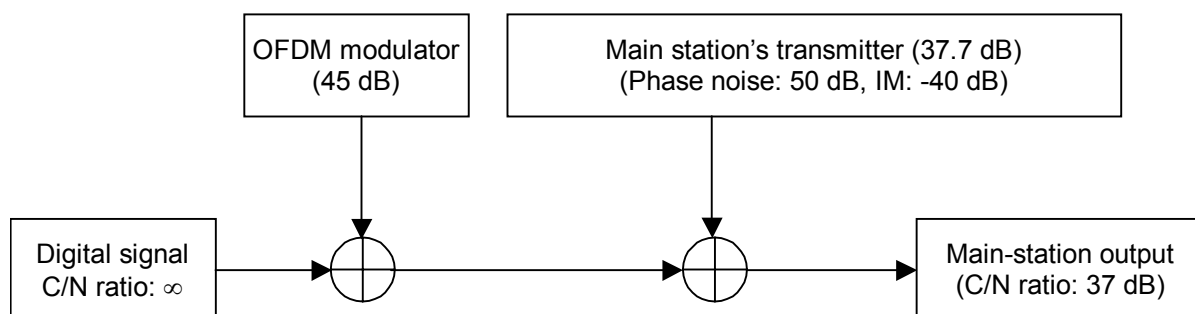

Fig. A3.2-2: Example of Distribution of the Equivalent C/N Ratio for the Main Station's Transmitter When a TS Transmission System is Used for STL (Case 1)

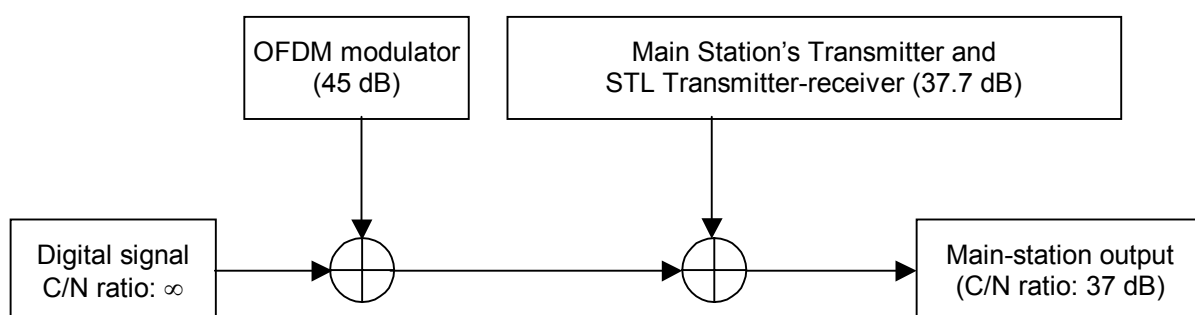

Fig. A3.2-3: Example of Distribution of the Equivalent C/N Ratio for the Main Station's Transmitter When an IF Transmission System is Used for STL (Case 2)

(3) Relay broadcasting equipment

- Reception of a signal from a higher-rank station

When we assume that broadcast waves are relayed, the possible factors causing a degraded C/N ratio during the reception of a signal by relay broadcasting equipment are thermal noise associated with field strength, multipath, interference, and the SFN sneak path.

We calculated the field strength at each stage for all analog UHF stations, and selected a level 10 dB below the level of field strength acceptable for 80% of all stations as the provisional value, as the transmission power for digital broadcasting is 10 dB lower than that for analog UHF.

As for the noise factor, we selected  $NF = 3$  dB as the provisional value in consideration of the actual noise factor for the current analog relay broadcasting equipment.

On the other hand, the extent to which the C/N ratio is degraded by multipath disturbance, interference, and the SFN sneak path varies substantially depending on the reception point, antenna used, and performance of the cancellers (if any). We believe, therefore, that each of these factors must be reviewed on an individual basis in the construction of your own network.

In this link budget, as discussed in (3) of Section A3.2.1, we used various provisional values necessary to implement 4-stage relaying of broadcast waves, and selected 38.2 dB as the equivalent C/N ratio for all types of distortion.

- Relay station's transmitter

The transmitter output at a relay station is likely to be lower than that of the main station. For this reason, we selected 48 dB as the provisional equivalent C/N ratio of a transmitter caused by IM, in consideration of the fact that an FF system can be used as discussed in (1) of Section A3.2.2. On the other hand, we selected 50 dB as equivalent C/N ratio caused by phase noise, as with the main station.

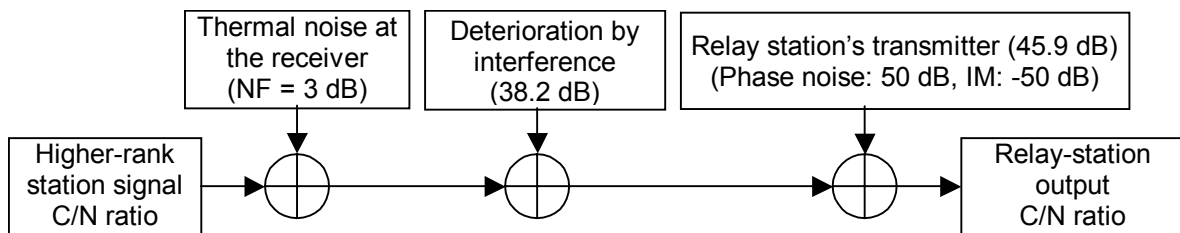

Fig. A3.2-4: Example of Distribution of the Equivalent C/N Ratio for the Relay Station's Transmitter

### A3.2.3 Reception model within service area

#### (1) Receiving antenna

According to the Fiscal 1999 Report of the Frequency Planning Technical Committee of the Telecommunication Technology Council, the channel plan was established under the assumption that a 14-element Yagi antenna would be used. For this reason, we selected a Yagi antenna with a gain of 7 dB.

#### (2) Field strength

We selected 60 dB $\mu$ V/m as the field strength based on said report.

As for the fading margin, we first made calculations to determine the size of the area for each stage in which the field strength was 70 dB $\mu$ V/m, a level that is currently required for analog broadcasting. Next, we calculated the distance that was acceptable for 95% of all stations. Finally, we selected the levels of fading margin in which a 99% time rate could be achieved.

Table A3.2-4: Fading Margin (in which a 99% Time Rate can be Achieved) Corresponding to an Area Size Acceptable for 95% of All Stations

	Main station	1st stage	2nd stage	3rd stage	4th stage	5th stage	6th stage	7th stage
Max. area radius	-	35 km	25 km	20 km	20 km	20 km	12 km	8 km
Fading margin	9 dB	5 dB	4 dB	4 dB	4 dB	4 dB	4 dB	4 dB

#### (3) Receiver thermal noise

Based on said report, we assumed that a low-noise booster (NF = 3.3 dB) would be used to prevent area fringe.

Note also that we selected 1 dB as the feeder loss from the antenna to the booster.

#### (4) Multipath disturbance and interference

Multipath disturbance within the service area varies substantially depending not only on the network status (affected by whether an SFN (Single-Frequency Network) is used), but also on the receiving-antenna location and neighboring buildings and structures. Note that interference disturbance caused by other digital waves and analog broadcast waves also varies drastically depending on the specific stationary-station conditions, receiving-antenna installation conditions, and fading between undesired and desired waves.

According to the link budget included in the Fiscal 1999 Report of the Frequency Planning Technical Committee of the Telecommunication Technology Council, a DU ratio of 10 dB (1 dB of degradation from a C/N ratio of 22 dB when 64QAM and 7/8 are selected as the modulation scheme and inner-code coding rate, respectively) was taken into consideration as multipath disturbance caused, for example, by SFN within the service area. In the same link budget, 2 dB of degradation from the C/N ratio of 22 dB was considered interference disturbance caused by analog broadcasting and other digital broadcasting.

For this reason, it is necessary to conduct a more specific and detailed survey within the service area. As a model case, we selected 25 dB as the equivalent C/N ratio for both multipath and interference disturbance, a ratio that corresponds to 3 dB of degradation from the required C/N ratio of 22 dB (C/N ratio at which  $2 \times 10^{-4}$  can be achieved following inner-code correction; see Fig. A3.2-5).

Note also that Fig. A3.2-6 shows the relationship between the multipath DU ratio (at which an equivalent C/N ratio of 25 dB can be achieved) and interference (co-channel interference). The equivalent C/N ratio is 25 dB in the area above the curve. When the levels of multipath disturbance and interference are above the curve (in the area to the upper right), the model-case requirement can be met, that is, an equivalent C/N ratio of 25 dB can be achieved.

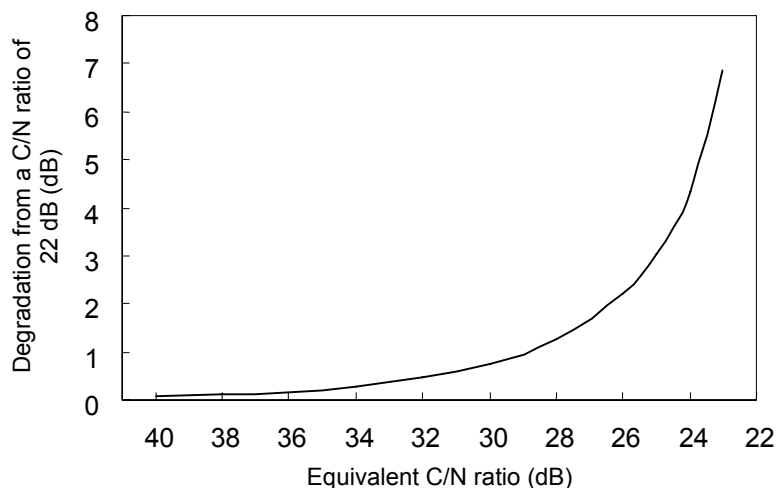

Fig. A3.2-5: Equivalent C/N Ratio as a Function of Degradation from a C/N Ratio of 22 dB

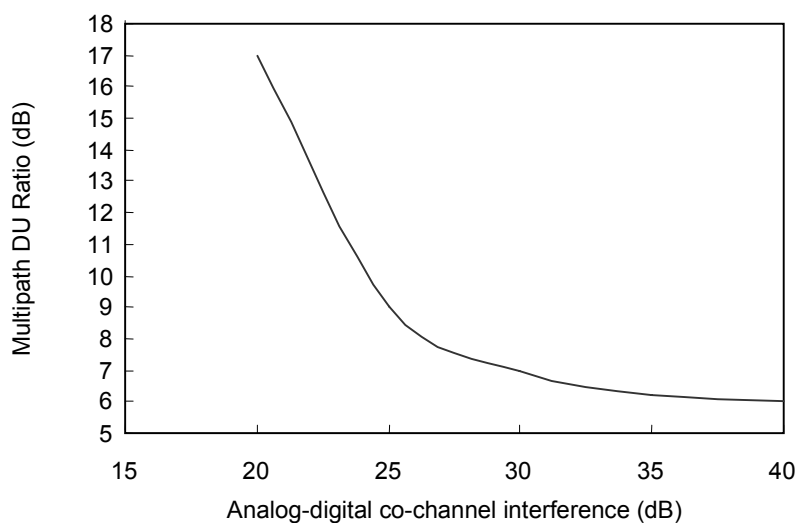

Fig. A3.2-6 Relationship between the Multipath DU Ratio (at which an Equivalent C/N Ratio of 25 dB can be achieved) and Co-Channel Interference

(5) Urban noise

We selected 700 K as the level of urban noise. This value is equivalent to that of 13 channels in the Fiscal 1999 Report of the Frequency Planning Technical Committee of the Telecommunication Technology Council.

(6) Receiver's deterioration

The equivalent C/N ratio of the receiver should be selected in consideration of the availability of commercial receivers. However, we selected 28 dB as the provisional equivalent C/N ratio (1.3 dB of degradation from 22 dB) for use as a model case in the link budget process.

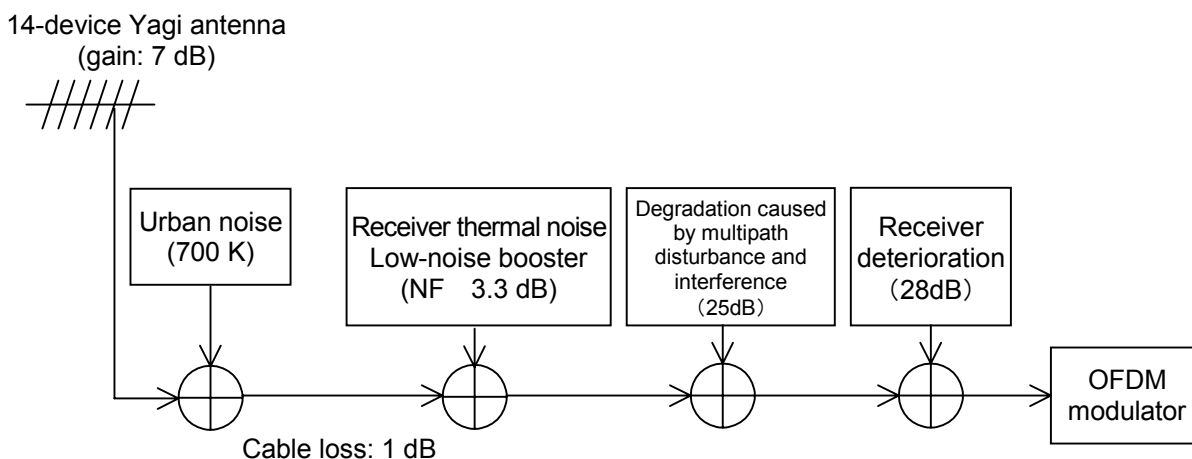

Fig. A3.2-7: Example of Distribution of the Equivalent C/N Ratio for the Reception Model

### A3.2.4 Provisional values selected for the link budget model

Table A3.2-5 lists the provisional values selected from Sections A3.2.1 to A3.2.3. As specified in these sections, these values were merely provisional, and were selected for link budget purposes. None of these values represents in any way the goals or guidelines for equipment development efforts.

Table A3.2-5: Provisional Values Selected for Link Budget Purposes

Equipment		Parameter	Provisional value	Remarks
STL	TS	Equivalent C/N ratio	$\infty$	No degradation with TS transmission system
	IF	Equivalent C/N ratio		To be evaluated in conjunction with the main station's transmitter characteristics
OFDM modulator		Equivalent C/N ratio	45 dB	Phase noise = 48 dB; 1M = -50 dB or less
Main station's transmitter		Equivalent C/N ratio as a result of phase noise	50 dB	
		Equivalent C/N ratio as a result of IM (During TS transmission)	38 dB	PD system, 1M = -40 dB or less
		Equivalent C/N ratio as a result of IM (During IF transmission)		37.7 dB (STL equivalent C/N ratio and phase noise combined)
Relay broadcasting equipment	Receiving system	Distance from previous stage	80%	80% of all stations included
		Circuit cutoff rate	0.1%	Area cutoff rate: 1% (99% time rate)
		Fading loss	99.9%	99.9% (based on UHF Television transmission and reception)
		Field strength	80%	Field-strength level acceptable for 80% of all stations (based on the field strengths at all analog UHF stations)
		Receiving antenna	1.8 m $\phi$	1.8 m grid parabola (gain: 13 dB)
		Feeder loss	2 dB	
		NF	3 dB	
	Equivalent C/N ratio (co-channel interference, multipath disturbance, SFN sneak path combined)	38.2 dB	Equivalent to 43 dB (if all 3 degradations occur under the same conditions)	
	Transmitting system	Equivalent C/N ratio as a result of phase noise	50 dB	Same as main station
		Equivalent C/N ratio as a result of IM	48 dB	FF system, IM = -50 dB or less
Receiver		Standard field strength	60 dB	Required field strength in the Fiscal 1999 Report of the Frequency Planning Technical Committee of the Telecommunication Technology Council
		Max. distance (transmission point – receiver)	95%	Max. radius acceptable for 95% of all stations
		Fading margin	99%	99% value based on area max. distance
		Receiving antenna	14-element	14-element Yagi antenna
		Feeder loss	1 dB	
		NF	3.3 dB	Use of booster
		Equivalent C/N ratio (interference and multipath disturbance combined)	25 dB	
Equivalent C/N ratio as a result of receiver deterioration	28 dB	1.3 dB of degradation from 22 dB		

### A3.3 Example of link budget

Table A3.3-1: Example of Link Budget for Relaying Broadcast Waves

		0th stage	1st stage	2nd stage	3rd stage	4th stage	5th stage	6th stage	7th stage	Remarks
(1) C/N of received waves	dB		37.0	33.9	32.2	31.0	30.0	29.2	28.5	0th stage: Main station
Distance from previous stage	km		52.5	25.1	23.1	16.3	23.7	9.5	5.8	80% value (number of stations)
Field strength	dBf	-	72.8	70.8	68.8	68.0	67.0	68.7	64.1	80% value (number of stations); UHF receiving stations only
Fading loss	dB	-	-13.1	-8.7	-8.4	-7.3	-8.5	-6.7	-4.1	99.9% value in terms of distance
Field strength during fading	dB	-	59.7	62.1	60.4	60.7	58.5	62.0	60.0	
Receiving-antenna gain	dBi	-	15.0	15.0	15.0	15.0	15.0	15.0	15.0	1.8 m grid parabola (50 Ω)
Adjustment value	dB	-	-3.7	-3.7	-3.7	-3.7	-3.7	-3.7	-3.7	2.1 (relative gain) + 1.6 (conversion from 50 Ω)
$\lambda/\pi$	dB	-	-13.9	-13.9	-13.9	-13.9	-13.9	-13.9	-13.9	13ch
Feeder loss	dB	-	-2.0	-2.0	-2.0	-2.0	-2.0	-2.0	-2.0	
Terminal correction value	dB	-	-6.0	-6.0	-6.0	-6.0	-6.0	-6.0	-6.0	
Terminal voltage	dBt	-	49.1	51.5	49.8	50.1	47.9	51.4	49.4	60 dBt (analog)
Value converted from dBm	dB	-	-107.0	-107.0	-107.0	-107.0	-107.0	-107.0	-107.0	50 Ω
(2) Received power	dBm	-	-57.9	-55.5	-57.2	-56.9	-59.1	-55.6	-57.6	
kTB	dB	-	-106.3	-106.3	-106.3	-106.3	-106.3	-106.3	-106.3	T = 300°, B = 5.6 MHz
Noise factor (NF)	dB	-	3.0	3.0	3.0	3.0	3.0	3.0	3.0	
(3) Noise power	dBm	-	-103.3	-103.3	-103.3	-103.3	-103.3	-103.3	-103.3	
(4) C/N of HA only	dB	-	45.4	47.8	46.1	46.4	44.2	47.7	45.7	(4) = (2) - (3)
(5) Total degradation as a result of interference, etc.			38.2	38.2	38.2	38.2	38.2	38.2	38.2	
(6) C/N of HA output (Main station: OFDM modulator)	dB	45.0	34.2	32.4	31.1	30.1	29.3	28.6	28.0	(6) = (1) + (4) + (5)
(7) C/N of transmitter (phase noise)	dB	50.0	50.0	50.0	50.0	50.0	50.0	50.0	50.0	Equivalent C/N ratio as a result of phase noise
(8) C/N of transmitter (IM)	dB	38.0	48.0	48.0	48.0	48.0	48.0	48.0	48.0	Equivalent C/N ratio as a result of IM
(9) C/N of relay-station output	dB	37.0	33.9	32.2	31.0	30.0	29.2	28.5	27.9	(9) = (6) + (7) + (8)

Standard received field strength	dBf	60.0	60.0	60.0	60.0	60.0	60.0	60.0	60.0	
Max. distance (transmission point - reception point)	km	*	35.0	25.0	20.0	20.0	20.0	12.0	8.0	Max. radius acceptable for 95% of all stations
Fading loss	dB	-9.0	-5.0	-4.0	-4.0	-4.0	-4.0	-4.0	-4.0	ITU-R P.370-7 (99% value)
Field strength during fading	dBf	51.0	55.0	56.0	56.0	56.0	56.0	56.0	56.0	
Receiving-antenna gain	dBd	7.0	7.0	7.0	7.0	7.0	7.0	7.0	7.0	14-element Yagi antenna (for 13 to 44 channels)
$\lambda/\pi$	dB	-13.9	-13.9	-13.9	-13.9	-13.9	-13.9	-13.9	-13.9	13ch
Terminal correction value	dB	-6.0	-6.0	-6.0	-6.0	-6.0	-6.0	-6.0	-6.0	
Terminal voltage	dBt	38.1	42.1	43.1	43.1	43.1	43.1	43.1	43.1	
Value converted from dBm	dB	-109.0	-109.0	-109.0	-109.0	-109.0	-109.0	-109.0	-109.0	75 Ω
(10) Received power	dBm	-70.9	-66.9	-65.9	-65.9	-65.9	-65.9	-65.9	-65.9	
Bandwidth: B	MHz	5.6	5.6	5.6	5.6	5.6	5.6	5.6	5.6	
Urban noise: 700 k	k	700.0	700.0	700.0	700.0	700.0	700.0	700.0	700.0	Ta
Ground temperature: 300 k	k	300.0	300.0	300.0	300.0	300.0	300.0	300.0	300.0	To
Booster noise factor (NF)	dB	3.3	3.3	3.3	3.3	3.3	3.3	3.3	3.3	Low-noise booster used
Feeder loss	dB	1.0	1.0	1.0	1.0	1.0	1.0	1.0	1.0	Between antenna and booster
(11) Noise power	dBm	-99.3	-99.3	-99.3	-99.3	-99.3	-99.3	-99.3	-99.3	KB(Ta+To+To*(NF*L-1))
(12) C/N of receiver only	dB	28.4	32.4	33.5	33.5	33.5	33.5	33.5	33.5	(12) = (10) - (11)
(13) C/N of receiver output	dB	27.9	30.1	29.8	29.1	28.4	27.8	27.3	26.9	(13) = (9) + (12)
(14) Interference and multipath C/N	dB	25.0	25.0	25.0	25.0	25.0	25.0	25.0	25.0	Equivalent C/N ratio as a result of interference and multipath disturbance
(15) Equivalent C/N ratio (receiver's equipment deterioration)	dB	28.0	28.0	28.0	28.0	28.0	28.0	28.0	28.0	
(16) Demodulator input C/N		22.0	22.4	22.4	22.2	22.1	21.9	21.8	21.7	(16) = (13) + (14) + (15)

Table A3.3-1 shows an example of link budget in which broadcast waves are assumed to be relayed. As discussed in (3) of Section A3.2.1, when the maximum number of stages for relaying broadcast waves is 4, a demodulator-input C/N ratio of 22 dB or higher is available, indicating that the C/N ratio requirement (22 dB) for 64QAM and the inner-code coding ratio of 7/8 are met.

Table A3.3-2 presents the transmission parameters and required C/N ratio selected for ISDB-T. As mentioned later in Section A3.6, the robust transmission parameters are selected against interference, the more margin is gained for the demodulator C/N ratio to be secured. However, such selection will result in lower transmission capacities, as shown in Table A3.3-3. Therefore, link budget must be carefully considered not only from service contents view point, but also from selection of transmission parameters.

**Table A3.3-2: Transmission Parameters and Required C/N Ratio**

Modulation scheme	Inner-code coding ratio				
	1/2	2/3	3/4	5/6	7/8
DQPSK	6.2 dB	7.7 dB	8.7 dB	9.6 dB	10.4 dB
16QAM	11.5 dB	13.5 dB	14.6 dB	15.6 dB	16.2 dB
64QAM	16.5 dB	18.7 dB	20.1 dB	21.3 dB	22.0 dB

**Table A3.3-3: Transmission Parameters and Data Rate**

Modulation scheme	Inner-code coding ratio				
	1/2	2/3	3/4	5/6	7/8
DQPSK	4.056 Mbit/s	5.409 Mbit/s	6.085 Mbit/s	6.761 Mbit/s	7.099 Mbit/s
16QAM	8.113 Mbit/s	10.818 Mbit/s	12.170 Mbit/s	13.522 Mbit/s	14.198 Mbit/s
64QAM	12.170 Mbit/s	16.227 Mbit/s	18.255 Mbit/s	20.284 Mbit/s	21.298 Mbit/s

Note: Mode 3 and a guard interval ratio of 1/8 are selected.

The transmission capacity or data rate represents the TS rate when all 13 segments are used (188 bytes).

### A3.4 Standard settings for transmitting equipment in network

Provisional values were used in the link budget for the ISDB-T transmission network shown in Section A3.3. Each value must be taken into consideration in the actual network construction process.

Note, however, that because we deal with a broadcasting network, the key factor in the design should be to protect the reception environment within the service area as much as possible.

For this reason, we present standard settings for transmitting equipment for reference purposes, to ensure a proper reception environment within the service area discussed in Section A3.2.3.

- (1) When the service area is large and requires a fading margin of approximately 9 dB, the equivalent  $C/N$  ratio for the main or relay station's transmitter output must be 37 dB.
- (2) When the service area is relatively small, with a fading margin of 5 dB or less, the equivalent  $C/N$  ratio for the main or relay station's transmitter output must be 30 dB.

If the corresponding criterion is met, the reception model within the service area discussed in Section A3.2.3 will be available.

Note, however, that with a very small area as in the case of a relay station at the end of a line or a gap filler, the reception environment within that area is likely to be relatively stable. In such a case, the equivalent  $C/N$  ratio of 30 dB is excessive and may result in increased transmitting-equipment costs. Therefore, extreme caution must be exercised in the use of the above values.

Fig. A3.4-1 shows the equivalent  $C/N$  ratio for the transmitter output as a function of the required received field strength within the service area.

When the output  $C/N$  ratio is 37 dB, program signals can be properly received as long as the received field strength is approximately 51 dB $\mu$ V/m. In this case, a fading margin of approximately 9 dB is ensured, considering that the standard field strength is 60 dB $\mu$ V/m.

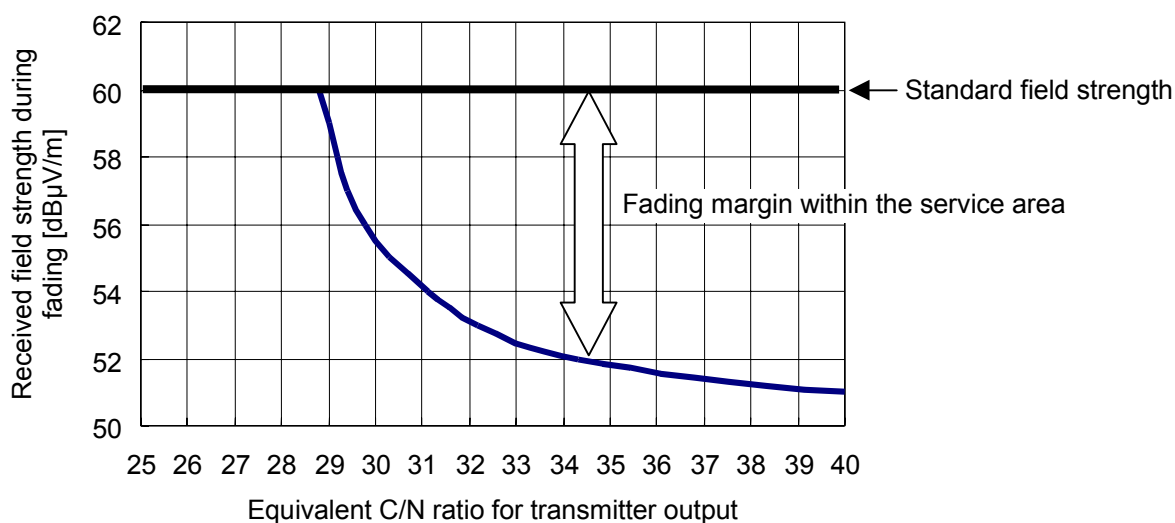

Fig. A3.4-1: Equivalent C/N Ratio for Transmitter Output as a Function of the Required Received Field Strength within the Service Area

Area radiuses and fading margins, obtained from the P370-7 propagation characteristics of the ITU-R Recommendations, are included in the appendix to the Fiscal 1999 Report of the Frequency Planning Technical Committee of the Telecommunication Technology Council.

Table A3.4-1: Fading Margins obtained from the P370-7 Propagation Characteristics of the ITU-R Recommendations

Transmission height	Area radius						
	10 km	20 km	30 km	40 km	50 km	70 km	100 km
300 m	1 dB	0.5 dB	1.5 dB	3 dB	4 dB	7 dB	11 dB
150 m	1 dB	1 dB	3 dB	5 dB	6 dB	9 dB	12 dB
75 m	2 dB	3 dB	4 dB	6 dB	6 dB	9 dB	12.5 dB
37.5 m	4 dB	4 dB	4 dB	6.5 dB	7 dB	9 dB	12 dB

When reviewing networks on an individual basis, first determine the fading margin based on the transmission height and area radius in Table A3.4-1 that correspond to the service area, and then find the equivalent C/N ratio for the transmitter output in Fig. 3.4-1 that is appropriate for the fading margin that was determined.

Note, however, that if there are any lower-rank stations, the service areas of those stations should be taken into consideration in determining the equivalent C/N ratio.

### A3.4.1 Study on the impact of changes to provisional values on overall link budget

(1) Impact of changes to the equivalent C/N ratio of the main station's transmitter

As discussed in (2) of Section A3.2.2, 37.7 dB was selected as the provisional equivalent C/N ratio of the main station's transmitter.

If this C/N ratio of main transmitter changes from 42 dB to 34 dB, the other transmitter-output C/N ratio changes as shown in Fig. A3.4-2. Note that in this case, the provisional values for relay stations given in Table A.3.2-5 were used.

This figure shows that it is possible to provide a transmitter-output C/N ratio of approximately 30 dB when the relay-station performance matches the provisional value, even if the equivalent C/N ratio of the main station's transmitter is approximately 34 dB, provided that the main station's service area is not excessively large and that there are no more than three stages of relay stations.

For this reason, there may be no problem, depending on the service-area status and the number of stages, even if the C/N ratio of the main station's transmitter is degraded, as long as the STL transmitter-receiver of the IF system is used.

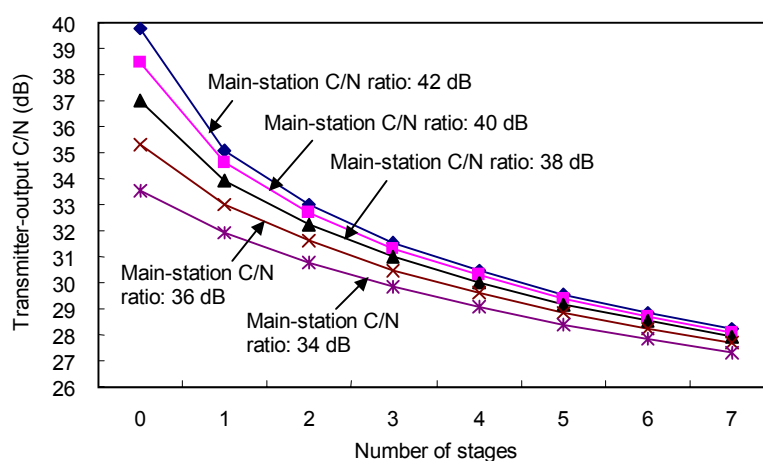

Fig. A3.4-2: Impact of Changes to the Equivalent C/N Ratio of the Main Station's Transmitter on the Transmitter-Output C/N Ratio

(2) Study on the use of multi-element Yagi antenna

A 14-element Yagi antenna was selected as the receiving antenna, and 7 dB was used as its gain. Table A3.4-3 shows the extent to which the reception C/N ratio can be improved when a high-gain antenna with gain of approximately 10 dB is used to prevent problems such as area fringe.

In general, the higher the antenna gain, the more directional the antenna becomes. As a result, such higher gain may provide reduced multipath and interference disturbance. However, the figure shows that if we suppose that impact of the disturbance remains unchanged, 3 dB of additional gain can improve the demodulator-input C/N ratio by only approximately 0.5 dB.

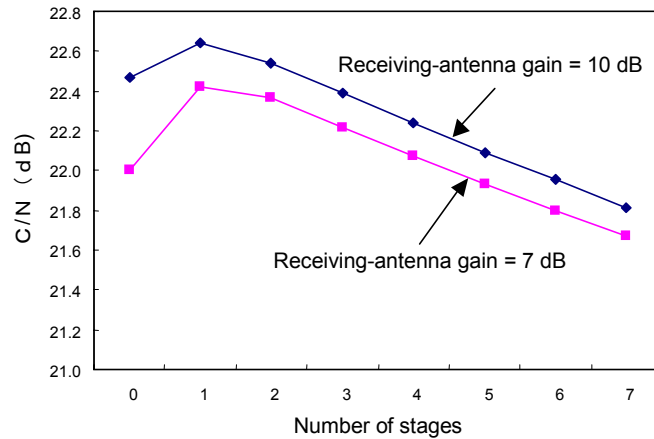

Fig. A3.4-3: Impact of Changes to the Receiving-Antenna Gain on the Demodulator-Input C/N Ratio

### **A3.5 Corrective actions if model case requirements cannot be met**

The link budget model requirements given in Section A3.2 are provisional values that have been specified for link budget purposes. Therefore, it may be difficult to meet these requirements through review on an individual basis.

However, as in A3.3, calculation results based on this link budget model indicate that if these requirements cannot be met, it may not be possible to receive program signals within the service area. For this reason, the following specifies the corrective actions to be taken if the model-case requirements cannot be met.

#### **A3.5.1 Corrective action if your stage-to-stage distance is longer than that in the model case**

The major problem in this case is a possible reduction in field strength at the relay station's receiver due to fading.

- (1) Use a receiving antenna larger than that (1.8 m in diameter) in the model case to increase the received voltage.
- (2) Connect multiple TTLs to ensure a more stable reception environment than when broadcast waves are relayed.
- (3) Provide an optical-fiber or other type of cable circuit.

Note, however, that if SFN is to be implemented, extreme caution should be exercised in establishing synchronization with the higher-rank station providing a digital circuit.

#### **A3.5.2 Corrective action if the multipath disturbance, SFN sneak path, and co-channel interference levels are higher than those in the model case**

In this case, the major problem is possible degradation of the equivalent  $C/N$  ratio of the output due to various types of interference at the relay station's receiver.

- (1) Use cancellers and properly select the reception position to reduce multipath and SFN sneak path.
- (2) Similarly, use cancellers and properly select the reception position to reduce co-channel interference. Keep in mind that cancellers may not provide a substantial improvement. Use TTLs to provide a stable reception environment.
- (3) When the SFN sneak path is a key problem to be addressed, change the frequency to provide MFN, if possible. Note that this choice is not readily feasible in terms of the current use of channels. However, it can be taken into consideration if frequencies are reorganized, as when analog broadcasting is terminated.

### **A3.5.3 Corrective action when there are many stages**

The model case discussed earlier shows that the relaying of broadcast waves with five stages or more would be difficult. For this reason, if there are many stages, the degradation of the C/N ratio at each stage must be reduced to a greater extent than in the model case.

- (1) Use TTLs, particularly at relay stations with high levels of multipath, SFN sneak path, and co-channel interference, to provide a better C/N ratio.
- (2) Use TS system TTLs. This eliminates the need to add noise from the previous stages. Then, consider reducing the number of stages in an equivalent manner.
- (3) Digital demodulation and, if necessary, error correction and other steps eliminate the need to total the noise, which has accumulated up to the MFN relay station, by OFDM demodulation and modulation. Note, however, that not only the demodulation and modulation processes but also the error-correction process produce delays. Therefore, caution should be exercised in the use of these processes.

### **A3.5.4 Corrective action when multipath and radio-interference conditions within the service area are harsher than in the model case**

If districts under harsh reception conditions are concentrated within a specific range, a supplementary relay station may be provided.

If districts under harsh reception conditions are scattered, depending on the multipath status, a receiving antenna with higher performance may be provided, a taller antenna may be used, or the antenna location may be changed. Note, however, that increased antenna gain will not offer any outstanding advantage, as discussed in (2) of Section A3.4.1. Therefore, the primary focus should be on improving the multipath DU ratio and improving the DU ratio in relation to undesired waves through improved directionality.

## **A3.6 Effect of changing transmission parameters, and problems**

In the Report of the Frequency Planning Technical Committee of the Telecommunication Technology Council, a study was conducted based on the assumption that the transmission parameters for terrestrial broadcasting (64QAM and an inner-code coding rate of 7/8) that would provide the maximum transmission capacity were used.

As shown in Table A3.3-2, replacing these parameters with those that offer better resistance to degradation could be highly effective. However, this will result in a lower transmission capacity. Therefore, this alternative should be reviewed in terms of video quality.

With some carriers, changing the transmitting-equipment settings will make it impossible to use transmission parameters in the future that provide the maximum transmission capacity, even if it is assumed that parameters offering better resistance to degradation are used. As a result, future expansion of the service may be hindered.

For this reason, the margin produced through the use of parameters that offer better resistance to degradation must be used primarily to ensure stable reception with the service area. It is preferable to leave the criteria for transmitting equipment unchanged.

### **A3.7 Specific network construction process**

A model case was used in the link budget discussed in this document. Therefore, it is necessary to gain a full understanding of propagation conditions and interference levels to enable the link budgets on an individual basis in each network construction effort.



---

TRANSMISSION SYSTEM FOR DIGITAL TERRESTRIAL  
TELEVISION BROADCASTING

ARIB STANDARD

ARIB STD-B31 VERSION 1.6-E2  
(November 30, 2005)

---

This Document is based on the ARIB standard of "Transmission System For Digital Terrestrial Television Broadcasting" in Japanese edition and translated into English in December, 2006.

Published by

Association of Radio Industries and Businesses

Nittochi Bldg. 11F  
1-4-1 Kasumigaseki, Chiyoda-ku, Tokyo 100-0013, Japan

TEL 81-3-5510-8590  
FAX 81-3-3592-1103

Printed in Japan  
All rights reserved

---